

K LINE





K LINE is an essential and functional solution of design that satisfies the most common requirements for the shelf supports.

K LINE has been developed with a highly captivating and elegant shape so that it can be used as a shelf support for both wood shelves and glass shelves, in the latter case simply by applying a bespoke layer of rubber.

A version of **K LINE** with a vertical pin of $\varnothing 5$ mm has been also developed in order to lock the shelf horizontally.

In any case, all the versions of **K LINE** respect the European regulation UNI EN 14749

Zinc alloy
Engineering plastic rubber



ASSEMBLING K LINE

1

INSERT THE SHELF DIAGONALLY INTO THE CABINET

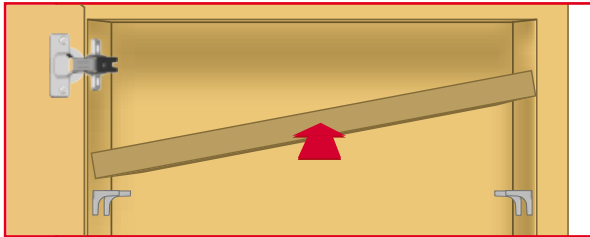

2

REST THE SHELF OVER THE K LINE SHELF SUPPORT

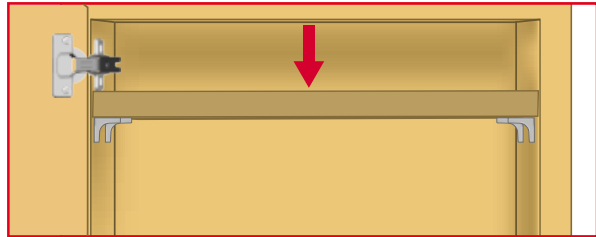

ASSEMBLING K LINE WITH LOCKING PIN

1

INSERT THE SHELF DIAGONALLY INTO THE CABINET

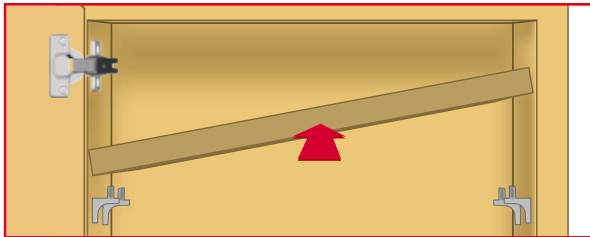

2

REST THE SHELF OVER THE K LINE SHELF SUPPORT

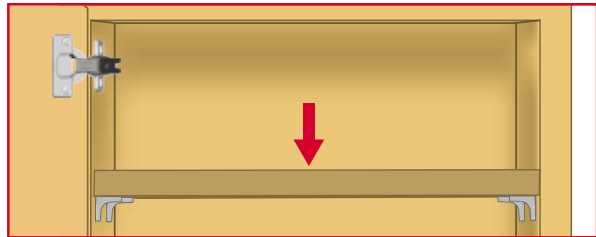

ASSEMBLING K LINE GLASS SHELF SUPPORT

1

INSERT THE (GLASS) SHELF DIAGONALLY INTO THE CABINET

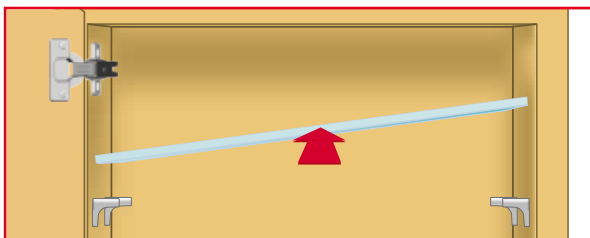

2

REST THE (GLASS) SHELF OVER THE K LINE GLASS SHELF SUPPORT

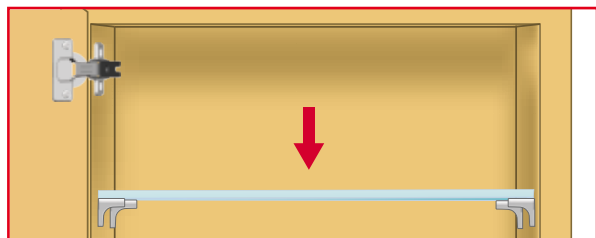

K LINE

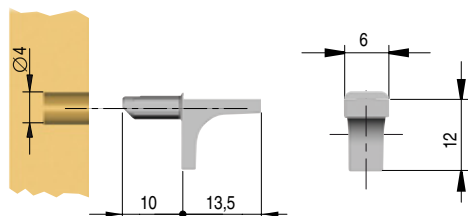

With \varnothing 4mm pin.

Part. no	Finish
10208110YA	Nickel-plated

Other finishes available on request

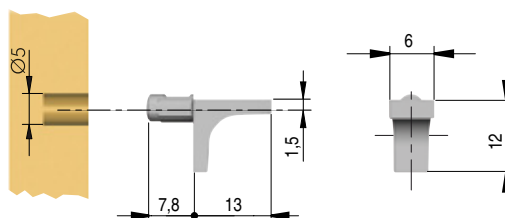

With \varnothing 5mm pin.

Part. no	Finish
10208020YA	Nickel-plated

Other finishes available on request

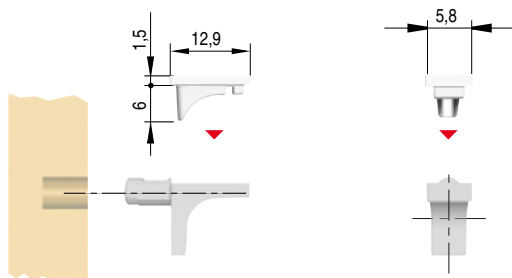

Clear rubber pad (supplied as separate part).

Part. no	Finish
10208060AA	Natural

K LINE WITH PIN TO LOCK THE SHELF HORIZONTALLY

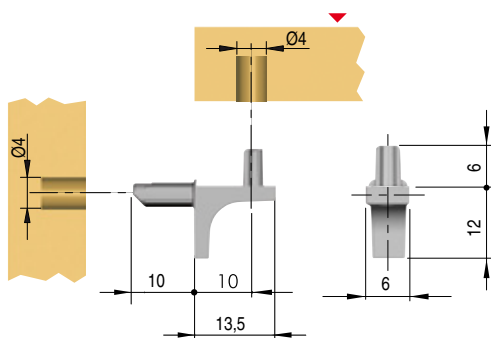

With \varnothing 4mm pin and \varnothing 4mm shelf-fixing lug.

Part. no	Finish
10208140YA	Nickel-plated

Other finishes available on request

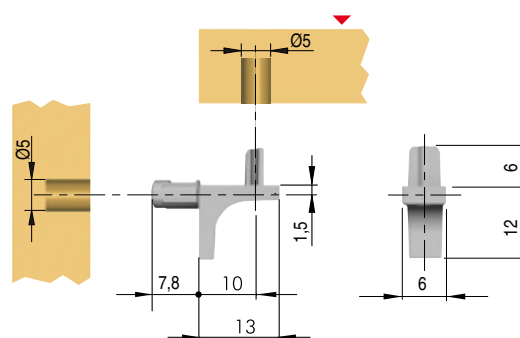

With \varnothing 5mm pin and \varnothing 5mm shelf-fixing lug.

Part. no	Finish
10208050YA	Nickel-plated

Other finishes available on request

K LINE SHELF SUPPORT WITH CLEAR RUBBER PAD INSERTED FOR GLASS SHELVES

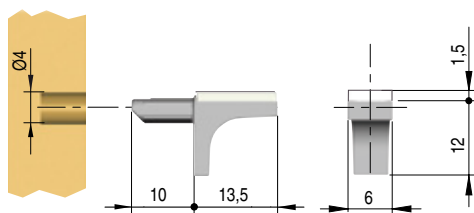

With \varnothing 4mm pin.

Part. no	Plastic	Finish
10208130YA	Natural	Nickel-plated

Other finishes available on request

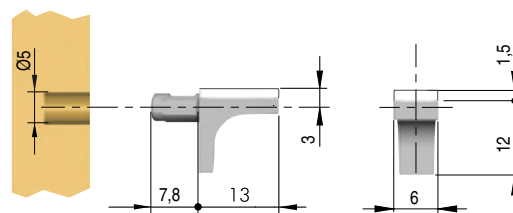

With \varnothing 5mm pin .

Part. no	Plastic	Finish
10208030YA	Natural	Nickel-plated

Other finishes available on request



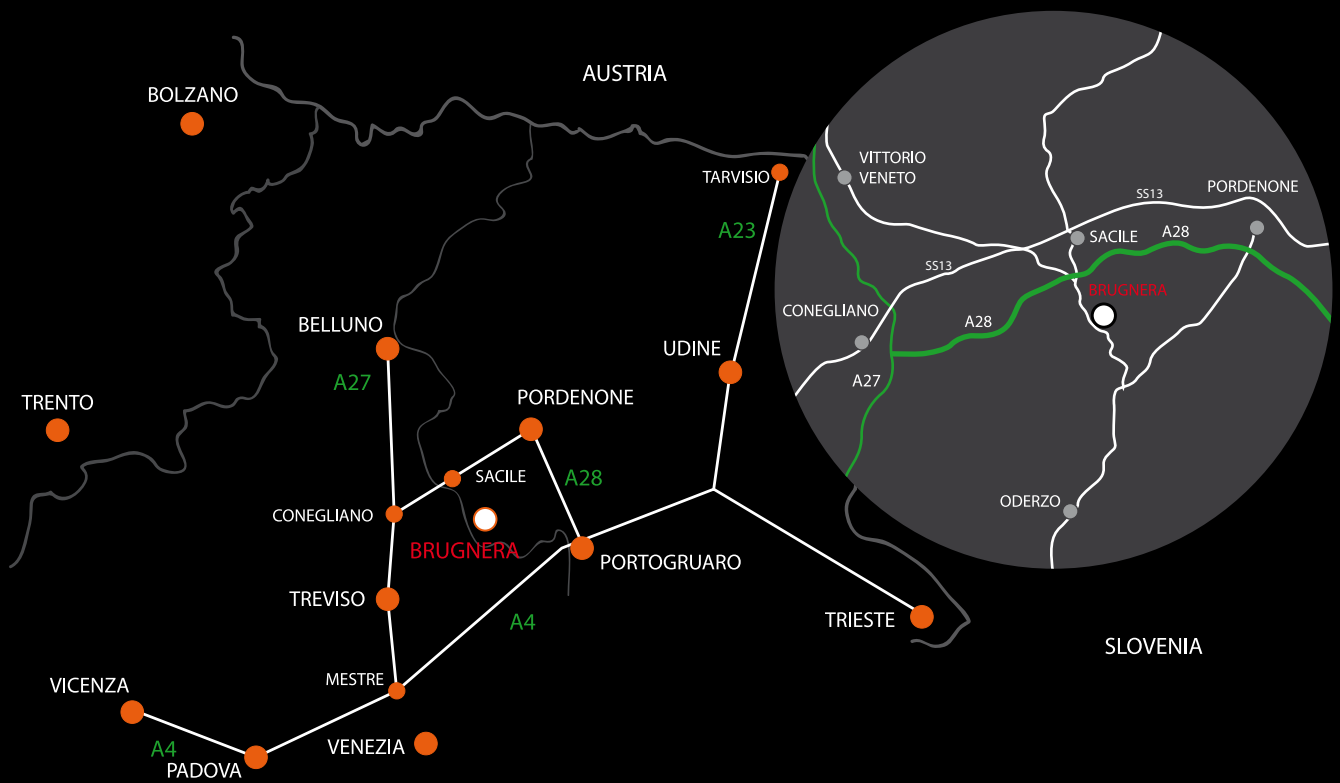

ITALIANA FERRAMENTA

Via Taglio n° 87 I - 33070 Maron di Brugnera (PN) Tel. +39 0434 428211 Fax +39 0434 428242 www.italianaferramenta.com info@italianaferramenta.it