

CATALOGO  
GENERALE

2017

**citterio**line



**citterio**line

---

MADE IN ITALY









Consapevoli della funzione sociale che ogni azienda deve avere Citterio Line da sempre ha adottato una politica rivolta alla salvaguardia dell'ambiente per un autentico sviluppo sostenibile. L'intero processo produttivo delle maniglie Citterio Line è caratterizzato da scelte orientate al più basso impatto ambientale, alla riduzione dei consumi, a sistemi alternativi di produzione dell'energia.

We realise that every company should emphasise social awareness and in the case of Citterio Line we have adopted a policy which aims to protect the environment by achieving a real, sustainable growth.

Our entire handle manufacturing process is characterized by choices aimed at reducing the environmental impact and waste and by searching for new, alternative energy producing systems.





Che cosa salta agli occhi e che cosa percepiscono le dita che sfogliano il nuovo catalogo Citterio Line? Ovviamente il messaggio della carta. La superficie piacevolmente morbida delle pagine dona un'immediata sensazione tattile e, al tempo stesso, consente di valorizzare gli oggetti in stampa, con dettagli perfettamente incisi e sfumature delicate ben pennellate sul foglio. Una scelta in linea con un concetto di "design da toccare"...il design espresso dalla collezione di maniglie d'arredamento di Citterio Line, pensate per soddisfare non solo i sensi bensì anche i più nobili ideali: belle, lisce e splendenti come la carta che le rappresenta.

What is immediately noticeable when leafing through the new Citterio Line Catalogue, apart from the contents?

The pleasantly soft surface of the pages offer a smooth sensation to the touch whilst, at the same time, highlighting and adding to the value of the printed matter itself, thanks to the perfectly engraved details and gentle nuances so beautifully represented on the paper.

This choice reflects the concept 'design to be touched'...a design represented by the handle collection of Citterio Line, studied not only to satisfy the senses but also the highest ideals: beautiful, smooth shiny handles like the paper which represents them.



Questo catalogo è stato realizzato nel pieno rispetto dell'ambiente.

This catalogue is an eco friendly product.





**citterio**line 

---

# PHOTOGRAPHIC

# CONTENTS

MANIGLIE  
A PONTE  
BRIDGE  
HANDLES



MANIGLIE  
PIENE  
FULL HANDLES



MANIGLIE  
SERIE QUADRA  
SQUARE HANDLES



MANIGLIE  
INCASSO  
BUILT-IN  
HANDLES



MANIGLIE  
A BARRA  
E PROFILI  
BAR HANDLES  
AND  
PROFILES



POMOLI E  
VARIE  
KNOBS AND  
VARIOUS  
HANDLES



MANIGLIE  
E POMOLI  
IN STILE  
CLASSIC  
HANDLES  
AND KNOBS





13



107



133

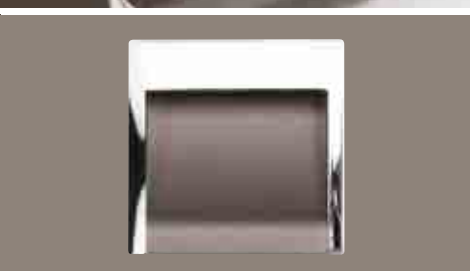

157



177



197



217



**citterio**line 

---

**MANIGLIE A PONTE**  
**BRIDGE HANDLES**

ARTICOLO - ARTICLE    INTERASSE - CENTER DISTANCE

302 A	160
302 C	96

ZAMA / ZAMAK









ARTICOLO - ARTICLE	INTERASSE - CENTER DISTANCE
303 A	192
303 B	160
303 C	128

ZAMA / ZAMAK



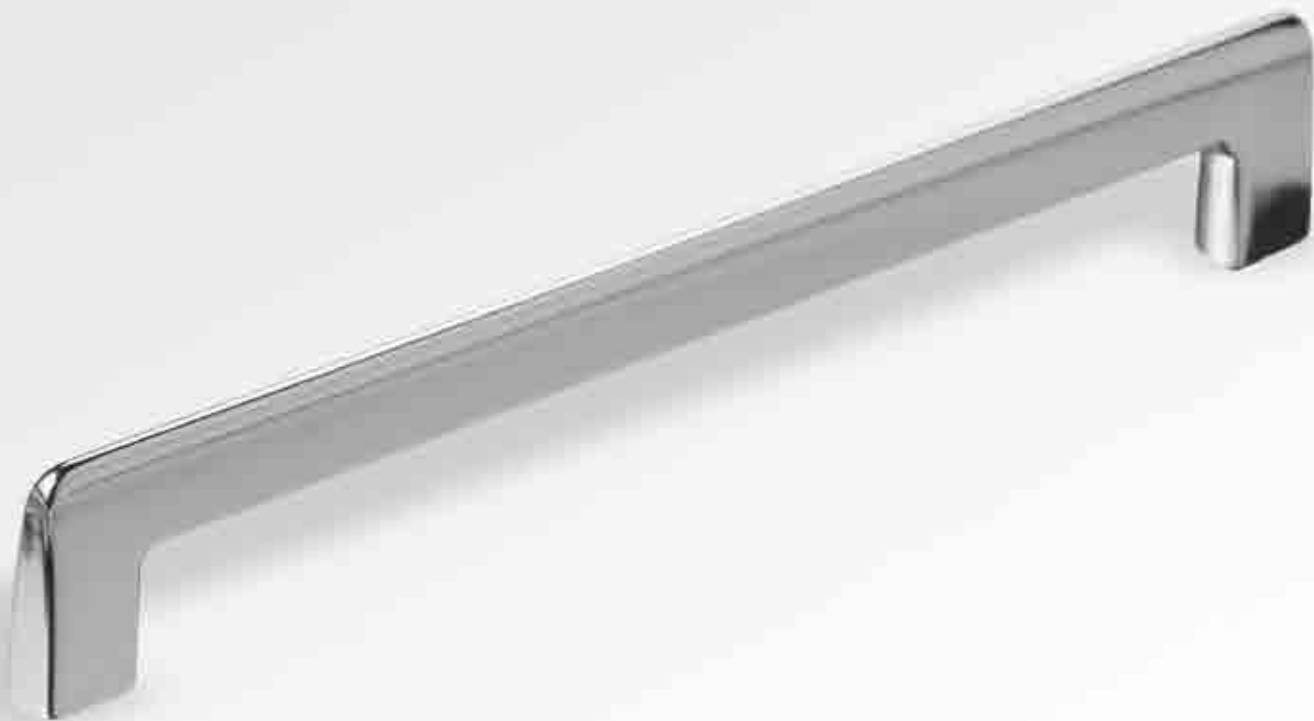

ARTICOLO - ARTICLE    INTERASSE - CENTER DISTANCE

304

224

ZAMA / ZAMAK

3 0 4



ARTICOLO - ARTICLE

INTERASSE - CENTER DISTANCE

305

160

ZAMA / ZAMAK





ARTICOLO - ARTICLE

INTERASSE - CENTER DISTANCE

339

128

ZAMA / ZAMAK



3 3 9







ARTICOLO - ARTICLE	INTERASSE - CENTER DISTANCE
306	160

ZAMA / ZAMAK



ARTICOLO - ARTICLE

INTERASSE - CENTER DISTANCE

308

160

ZAMA / ZAMAK



3 0 8





ARTICOLO - ARTICLE	INTERASSE - CENTER DISTANCE
315 A	192
315 B	160
315 C	96

ZAMA / ZAMAK



ARTICOLO - ARTICLE	INTERASSE - CENTER DISTANCE
322 A	160
322 B	128
322 C	32

ZAMA / ZAMAK







ARTICOLO - ARTICLE	INTERASSE - CENTER DISTANCE
323	224
323	192

ZAMA / ZAMAK

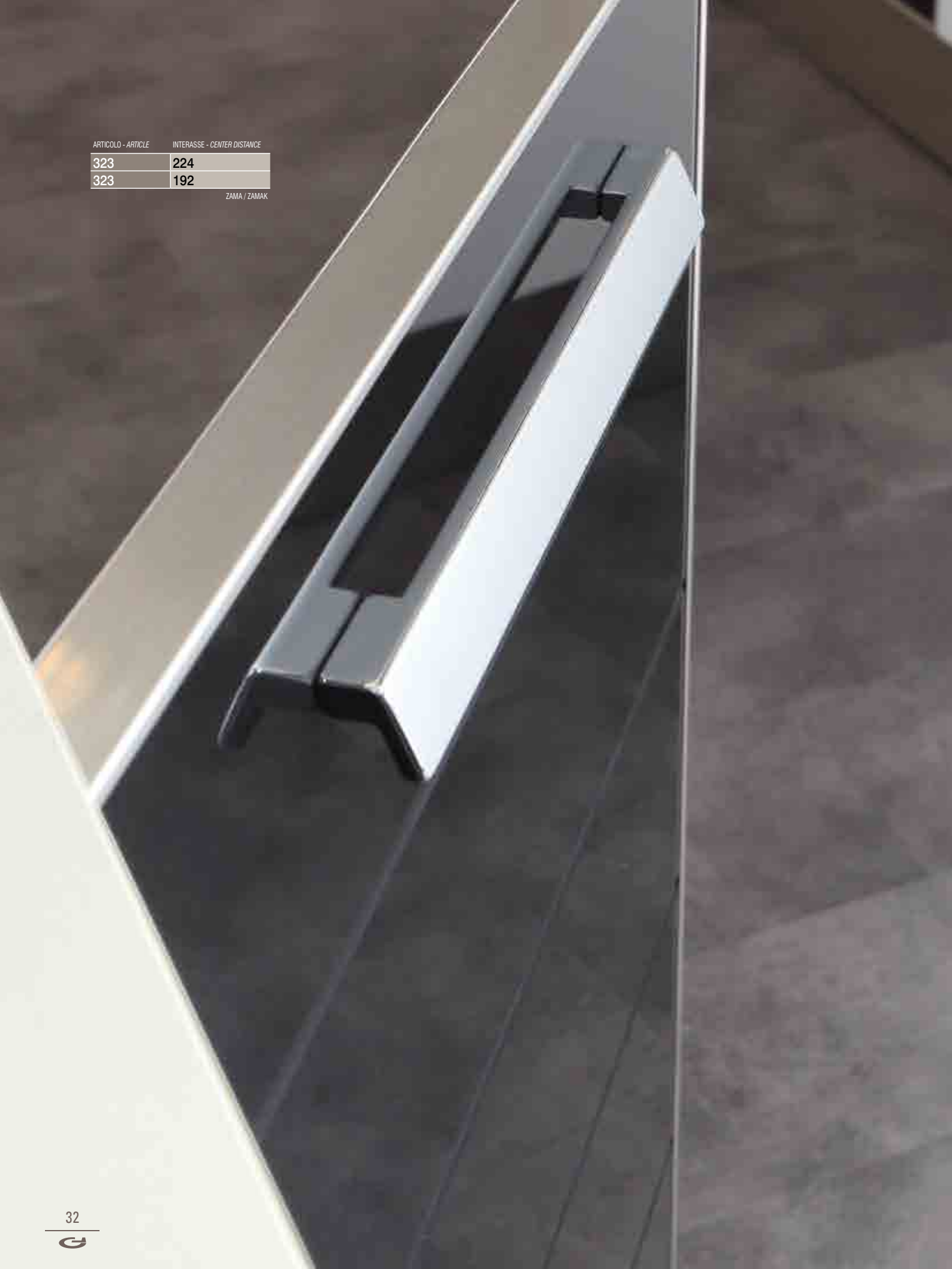





3 2 4

ARTICOLO - ARTICLE

324

INTERASSE - CENTER DISTANCE

32

ZAMA / ZAMAK





ARTICOLO - ARTICLE	INTERASSE - CENTER DISTANCE
329	160
329 SP	160

ZAMA / ZAMAK



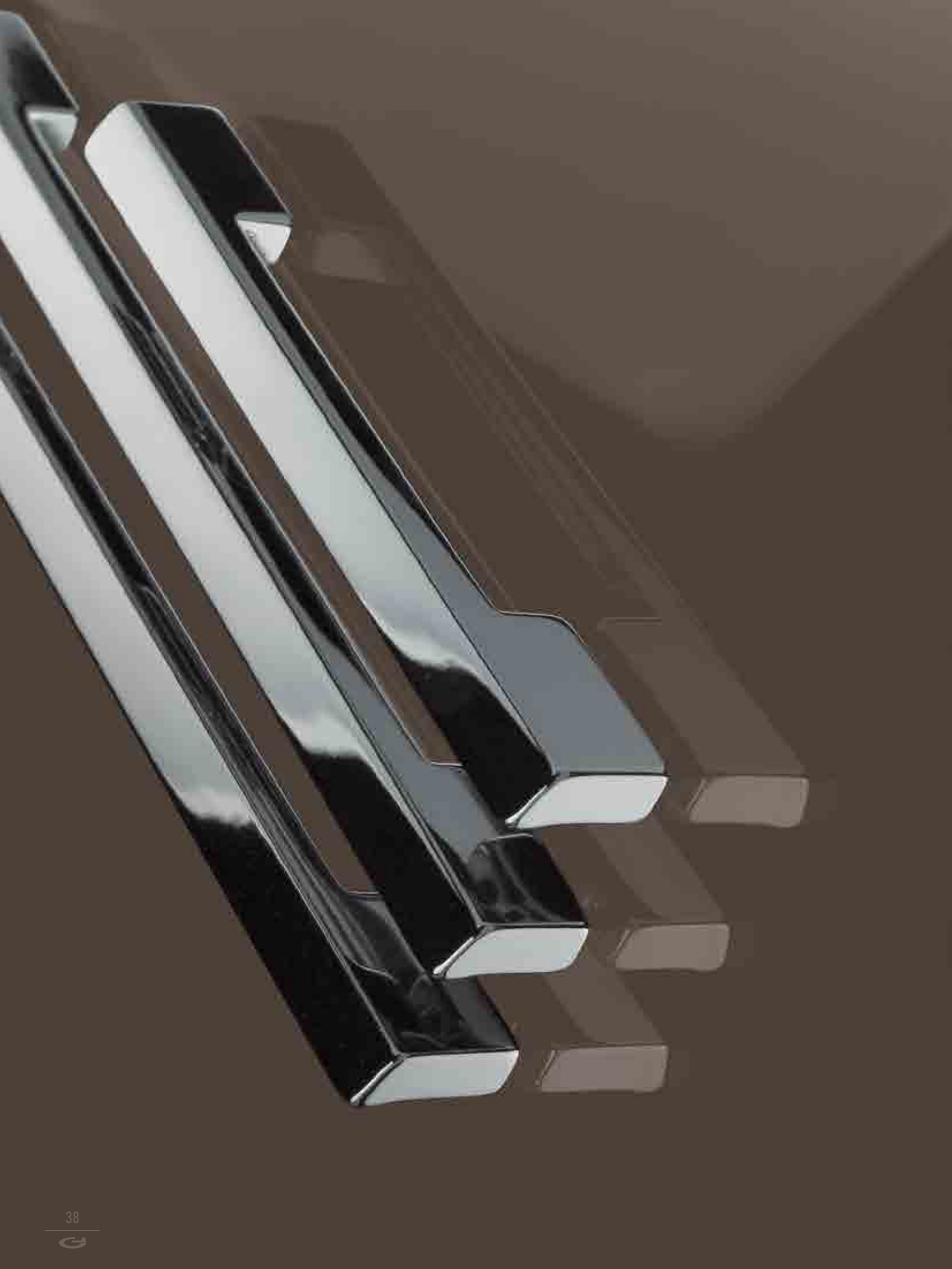

# 3 2 7

ARTICOLO - ARTICLE	INTERASSE - CENTER DISTANCE
327 A	192
327 A	160
327 B	128
327 B	96

ZAMA / ZAMAK







3 4 3

ARTICOLO - ARTICLE	INTERASSE - CENTER DISTANCE
343	320
343	288

ZAMA / ZAMAK







ARTICOLO - ARTICLE	INTERASSE - CENTER DISTANCE
328	192
328	160

ZAMA / ZAMAK





ARTICOLO - ARTICLE	INTERASSE - CENTER DISTANCE
330	192
330	160

ZAMA / ZAMAK

ARTICOLO - ARTICLE	INTERASSE - CENTER DISTANCE
332 A	160
332 B	128

ZAMA / ZAMAK









3 3 5

ARTICOLO - ARTICLE

335

INTERASSE - CENTER DISTANCE

96

ZAMA / ZAMAK



ARTICOLO - ARTICLE

INTERASSE - CENTER DISTANCE

337

160

ZAMA / ZAMAK



2 0 4 5



3 3 7



2 0 3 2

ARTICOLO - ARTICLE	INTERASSE - CENTER DISTANCE
338 A	192
338 A	160
338 B	128

ZAMA / ZAMAK

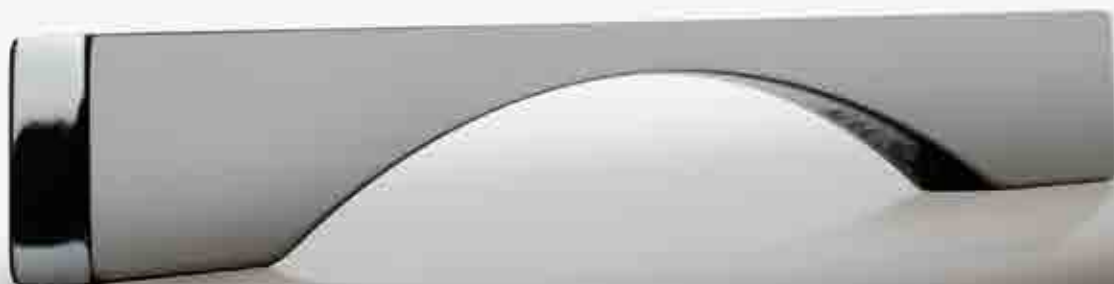





ARTICOLO - ARTICLE	INTERASSE - CENTER DISTANCE
340	128
340	96

ZAMA / ZAMAK





ARTICOLO - ARTICLE

INTERASSE - CENTER DISTANCE

346

192

ZAMA / ZAMAK



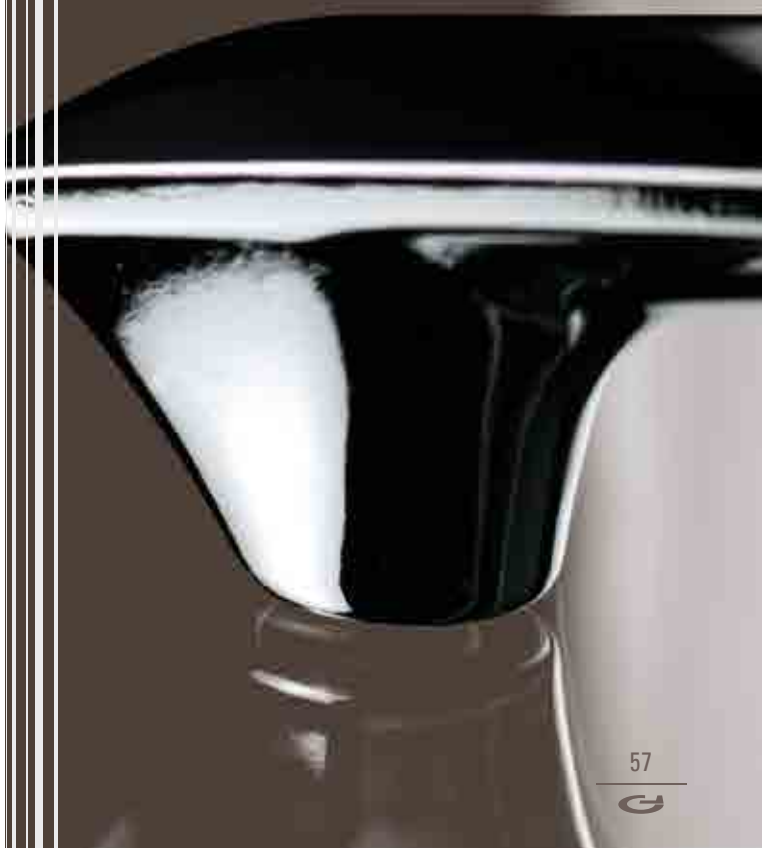

ARTICOLO - ARTICLE	INTERASSE - CENTER DISTANCE
347 A	320
347 B	192
347 B	160

ZAMA / ZAMAK





ARTICOLO - ARTICLE	INTERASSE - CENTER DISTANCE
350 A	320
350	256
350	224
350 B	160

ZAMA / ZAMAK

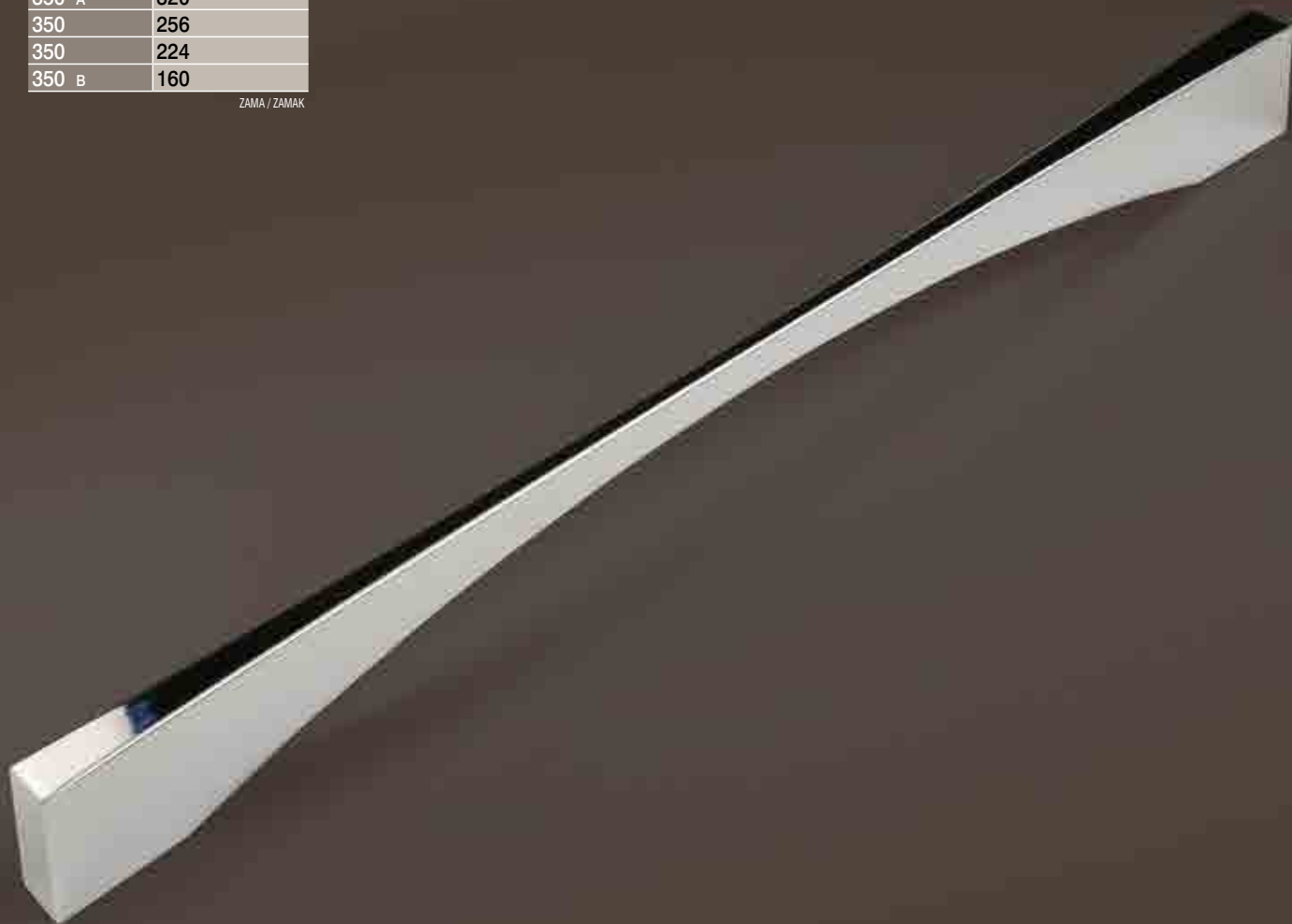

3 5 0

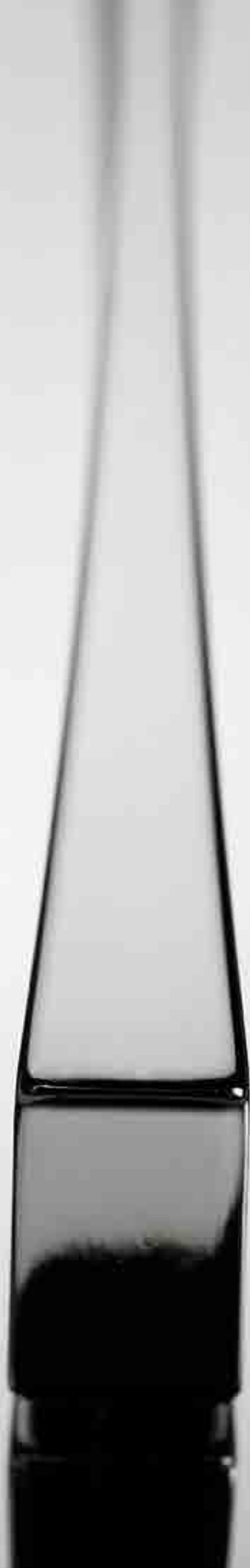





ARTICOLO - ARTICLE	INTERASSE - CENTER DISTANCE
355	160
355	128

ZAMA / ZAMAK







ARTICOLO - ARTICLE INTERASSE - CENTER DISTANCE

357 A	320
357 A	256
357 B	192
357 B	160
357 C	128
357 C	96

ZAMA / ZAMAK - ALLUMINIO / ALUMINIUM

ARTICOLO - ARTICLE	INTERASSE - CENTER DISTANCE
360 A	320
360 B	160
360 C	96

ZAMA / ZAMAK



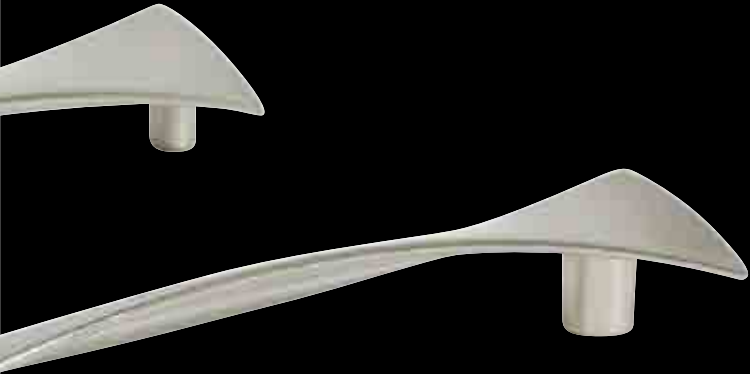



3 6 2



ARTICOLO - ARTICLE	INTERASSE - CENTER DISTANCE
362 B	224

ZAMA / ZAMAK



3 6 4



ARTICOLO - ARTICLE	INTERASSE - CENTER DISTANCE
364	480
364	320
364	160

ZAMA / ZAMAK - VETRO / GLASS





ARTICOLO - ARTICLE	INTERASSE - CENTER DISTANCE
370	480
370	320
370	160

ZAMA / ZAMAK - VETRO / GLASS

3 7 0





3 6 7

ARTICOLO - ARTICLE

367

INTERASSE - CENTER DISTANCE

96

ZAMA / ZAMAK





3 6 8

ARTICOLO - ARTICLE	INTERASSE - CENTER DISTANCE
368 A	320
368 A	288
368 B	224
368 B	192
368 C	160
368 C	128
368 D	96
368 D	64

ZAMA / ZAMAK



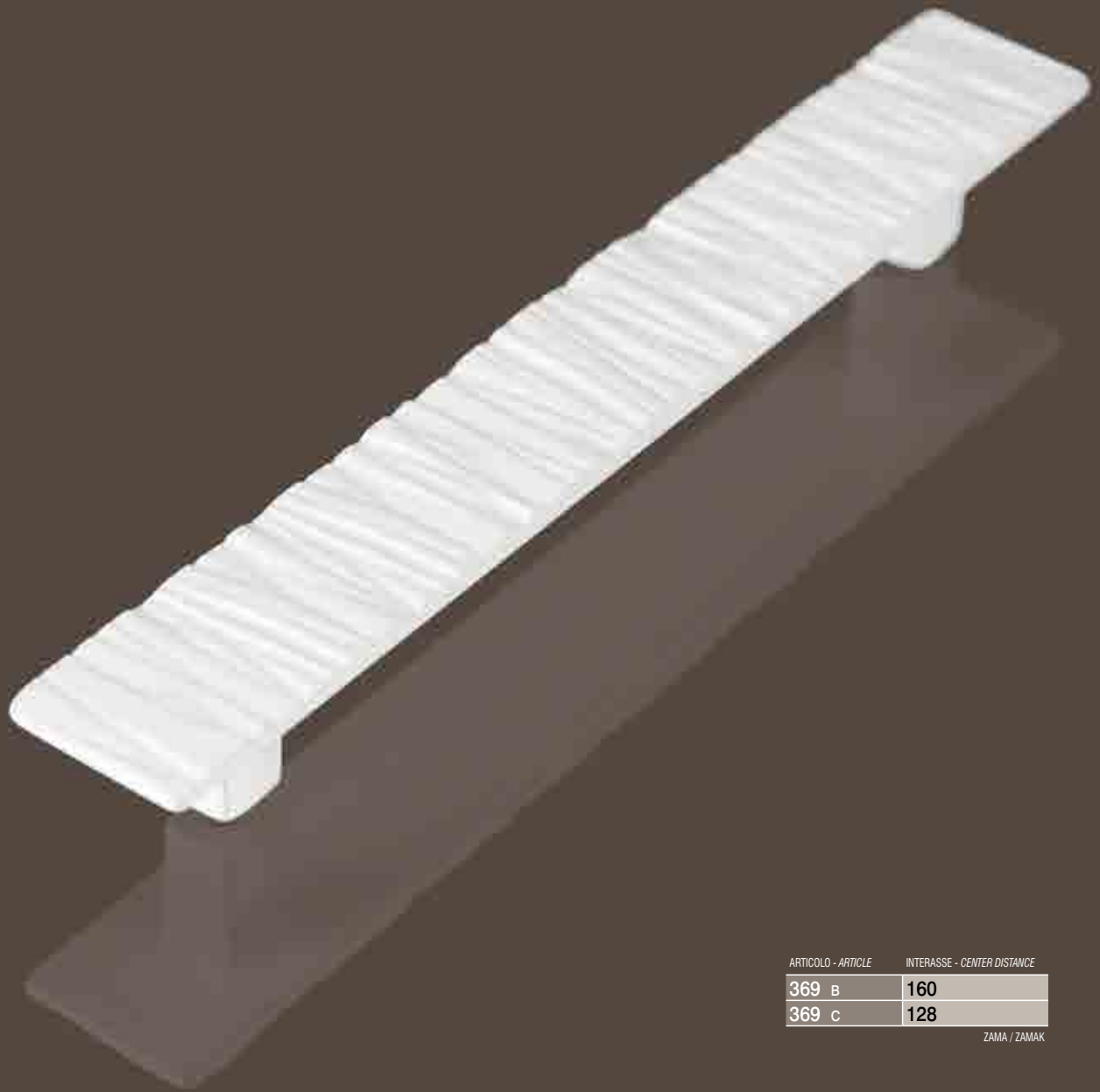

ARTICOLO - ARTICLE	INTERASSE - CENTER DISTANCE
369 B	160
369 C	128

ZAMA / ZAMAK

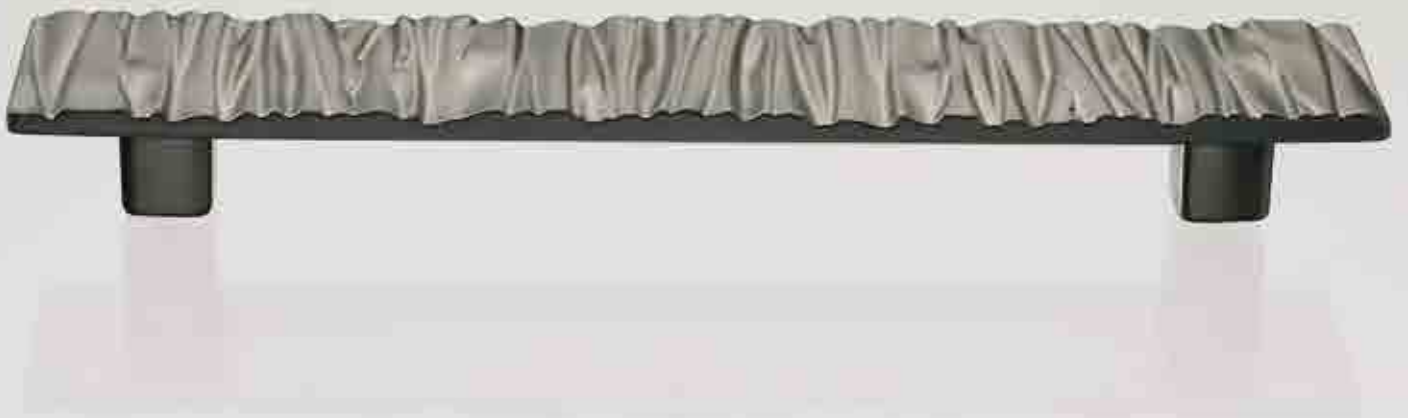





ARTICOLO - ARTICLE	INTERASSE - CENTER DISTANCE
377 B	320
377 C	160

ZAMA / ZAMAK



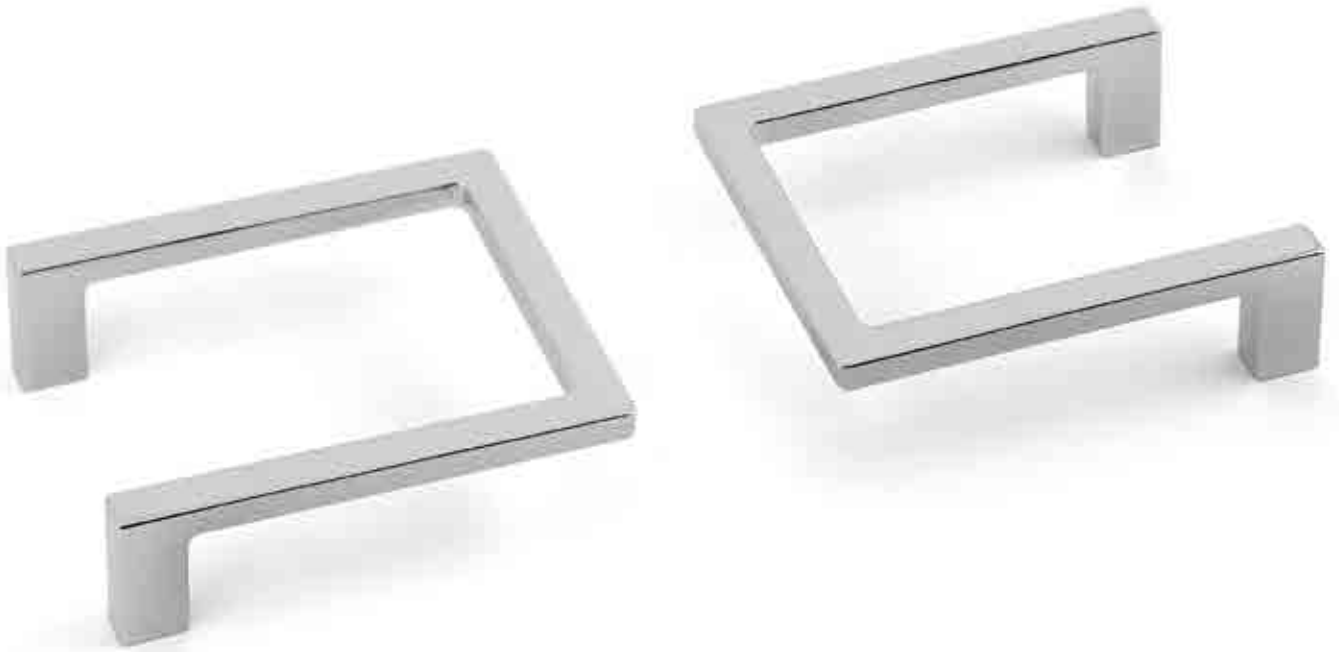

ARTICOLO - ARTICLE	INTERASSE - CENTER DISTANCE
379	64

ZAMA / ZAMAK



3 8 2

ARTICOLO - ARTICLE	INTERASSE - CENTER DISTANCE
382 A	320
382 C	160

ZAMA / ZAMAK



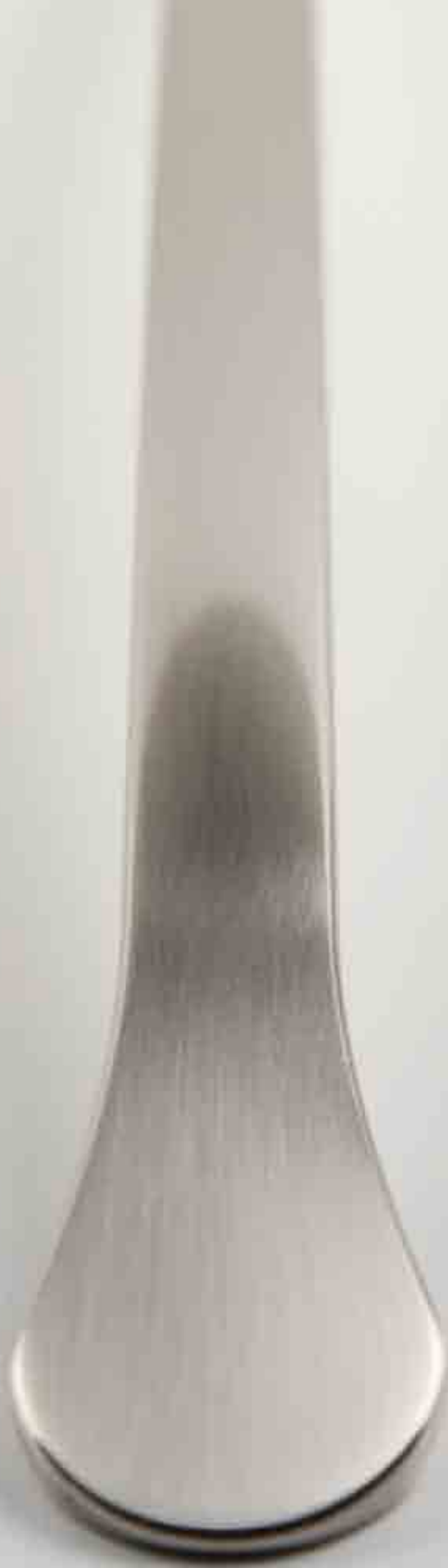

3 8 3



ARTICOLO - ARTICLE	INTERASSE - CENTER DISTANCE
383 A	320
383 C	160

ZAMA / ZAMAK



3 8 4



ARTICOLO - ARTICLE      INTERASSE - CENTER DISTANCE

384 A	96
384 B	64

ZAMA / ZAMAK

3 8 5



ARTICOLO - ARTICLE	INTERASSE - CENTER DISTANCE
385 B	128
385 C	96

ZAMA / ZAMAK



ARTICOLO - ARTICLE	INTERASSE - CENTER DISTANCE
386 A	320
386 C	160
386 D	96

ZAMA / ZAMAK





ARTICOLO - ARTICLE	INTERASSE - CENTER DISTANCE
387 A	256
387 A	224
387 B	160
387 C	96

ZAMA / ZAMAK



3 9 2

ARTICOLO - ARTICLE	INTERASSE - CENTER DISTANCE
392 A	320
392 A	288
392 B	192
392 B	160
392 A-K	320
392 A-K	288
392 B-K	192
392 B-K	160

ZAMA / ZAMAK - CRISTALLI / CRYSTALS



2 0 4 8



ARTICOLO - ARTICLE	INTERASSE - CENTER DISTANCE
2048	32

ZAMA / ZAMAK

ARTICOLO - ARTICLE	INTERASSE - CENTER DISTANCE
393 c	128

ZAMA / ZAMAK





3 9 4



ARTICOLO - ARTICLE	INTERASSE - CENTER DISTANCE
394 A	320
394 B	160

ZAMA / ZAMAK

3 9 7

ARTICOLO - ARTICLE INTERASSE - CENTER DISTANCE

**397 B** **160**

ZAMA / ZAMAK



3 9 8

ARTICOLO - ARTICLE INTERASSE - CENTER DISTANCE

**398 B** **160**

ZAMA / ZAMAK



3 9 9

ARTICOLO - ARTICLE INTERASSE - CENTER DISTANCE

**399 B**

**160**

ZAMA / ZAMAK



4 0 0



ARTICOLO - ARTICLE INTERASSE - CENTER DISTANCE

400 A 320

400 B 160

ZAMA / ZAMAK

4 0 1



ARTICOLO - ARTICLE INTERASSE - CENTER DISTANCE

401 A 320

401 B 160

ZAMA / ZAMAK



ARTICOLO - ARTICLE	INTERASSE - CENTER DISTANCE
402 B	192
402 B	160

ZAMA / ZAMAK

4 0 3



ARTICOLO - ARTICLE    INTERASSE - CENTER DISTANCE

<b>403 B</b>	<b>160</b>
--------------	------------

ZAMA / ZAMAK

ARTICOLO - ARTICLE      INTERASSE - CENTER DISTANCE

406 B	160
406 C	96

ZAMA / ZAMAK











**citterio**line 

---

**MANIGLIE PIENE  
FULL HANDLES**



3 0 1



ARTICOLO - ARTICLE	INTERASSE - CENTER DISTANCE
301 A	192
301 B	128

ZAMA / ZAMAK

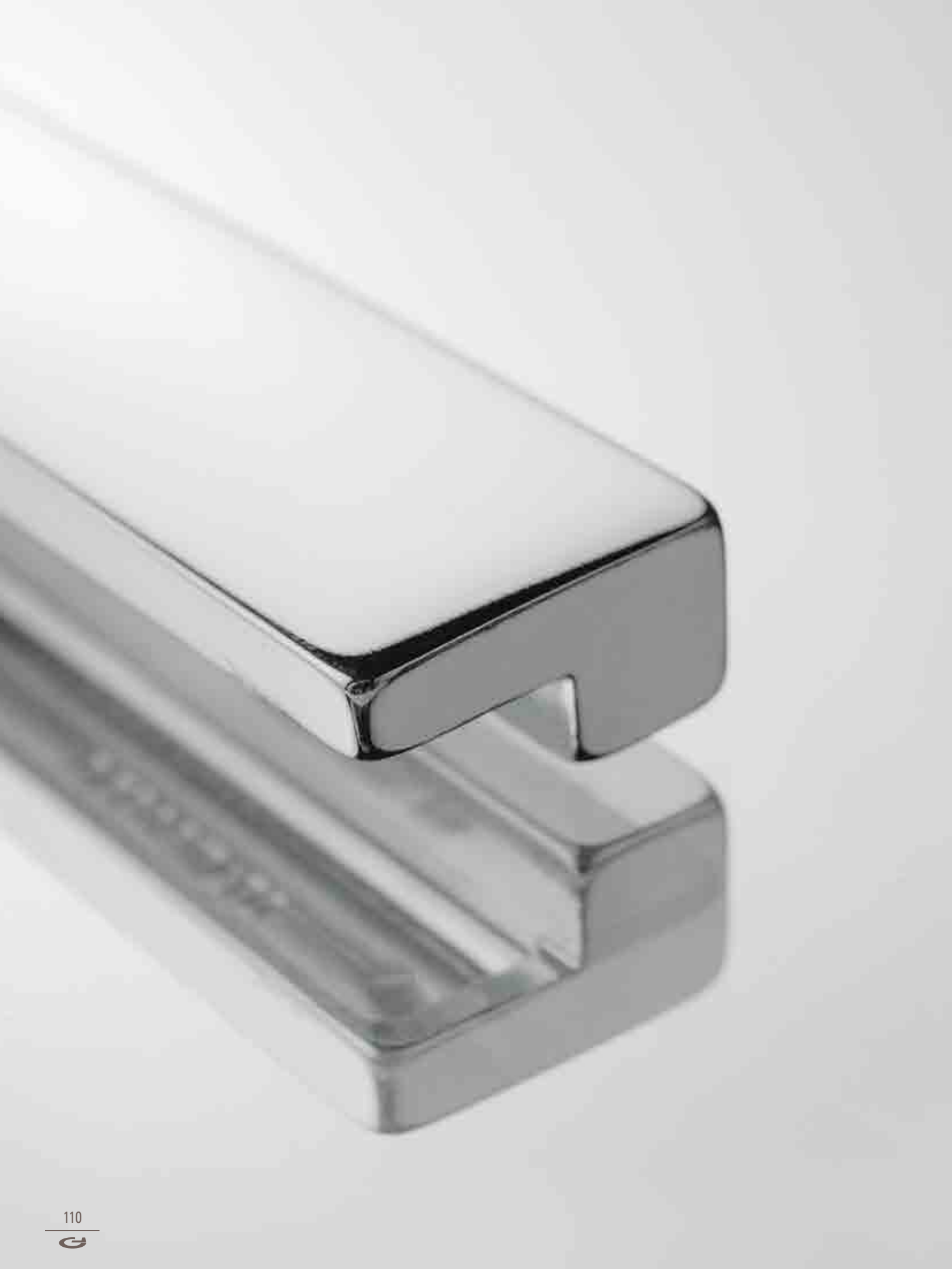

ARTICOLO - ARTICLE	INTERASSE - CENTER DISTANCE
313 A	160
313 B	128
313 B	64
313 C	96
313 C	64
313 D	16
313 D	FORO CENTRALE / CENTRAL HOLE

ZAMA / ZAMAK





3 1 6

ARTICOLO - ARTICLE	INTERASSE - CENTER DISTANCE
316	128
316	96

ZAMA / ZAMAK

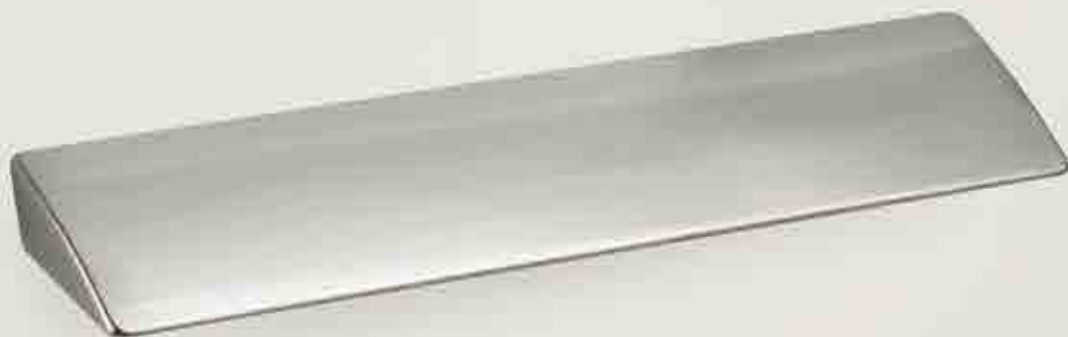
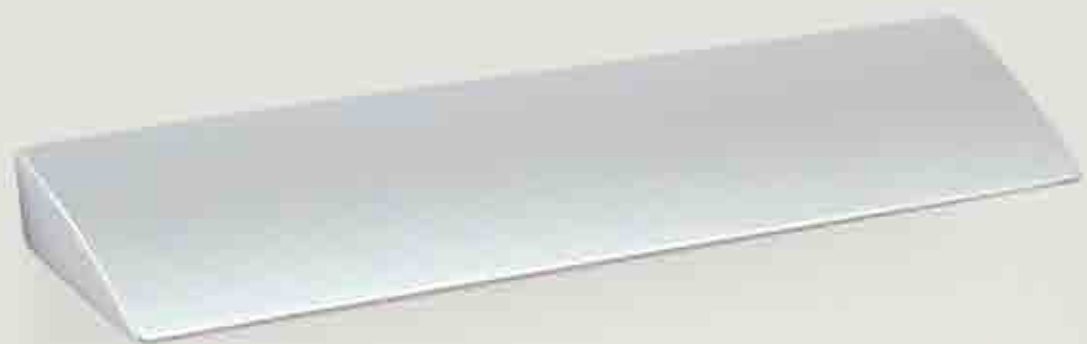

3 1 7

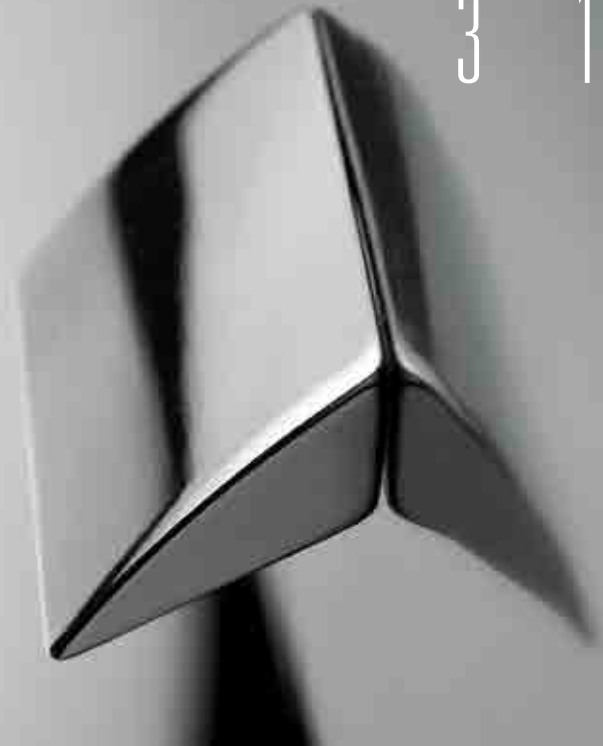

ARTICOLO - ARTICLE	INTERASSE - CENTER DISTANCE
317	32

ZAMA / ZAMAK



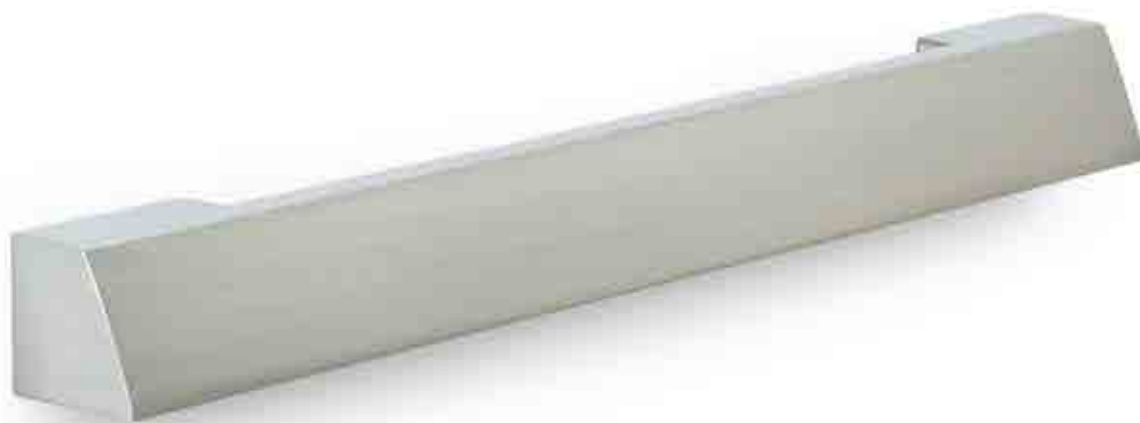

ARTICOLO - ARTICLE	INTERASSE - CENTER DISTANCE
325	192
325	160

ZAMA / ZAMAK

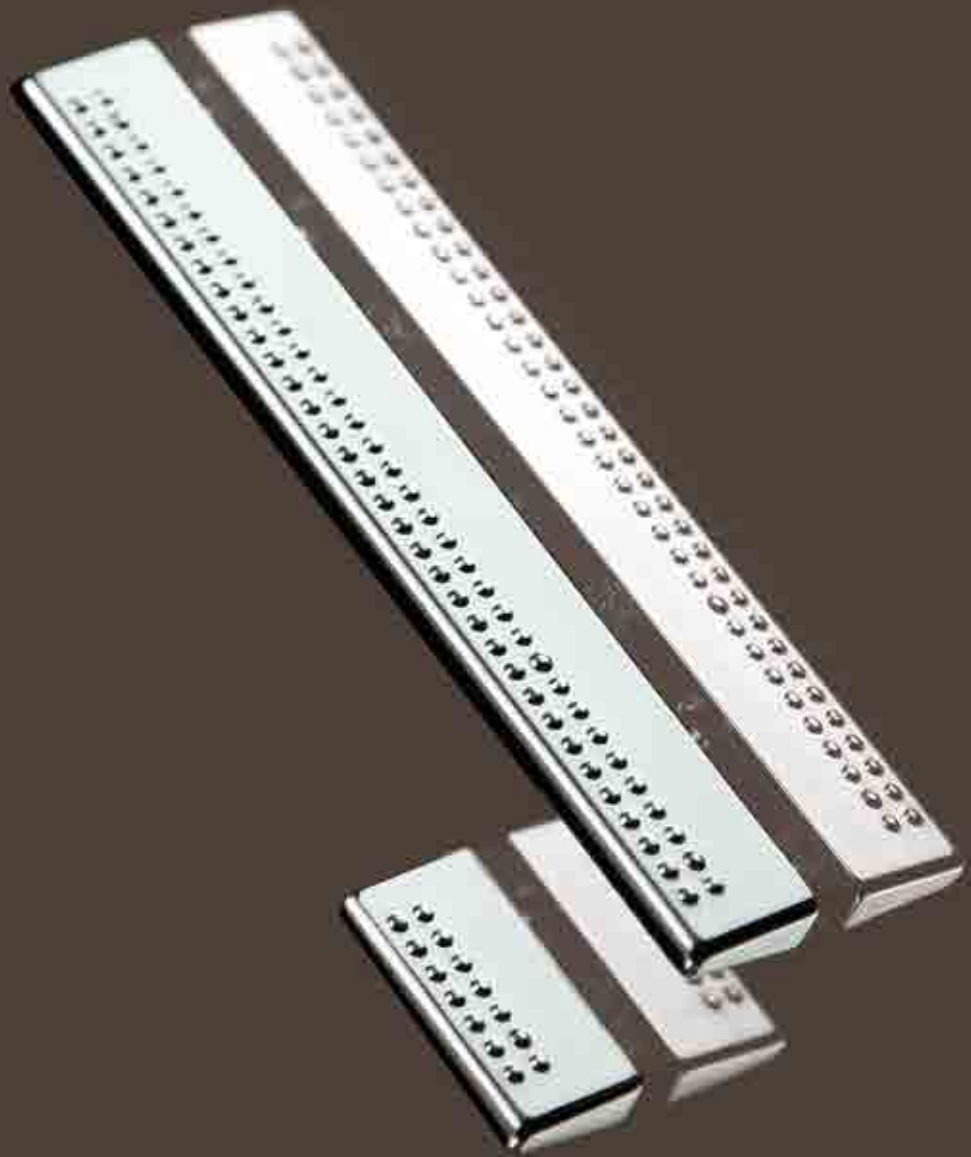

ARTICOLO - ARTICLE	INTERASSE - CENTER DISTANCE
326 B	96
326 B	64
326 C	16
326 C	FORO CENTRALE / CENTRAL HOLE

ZAMA / ZAMAK

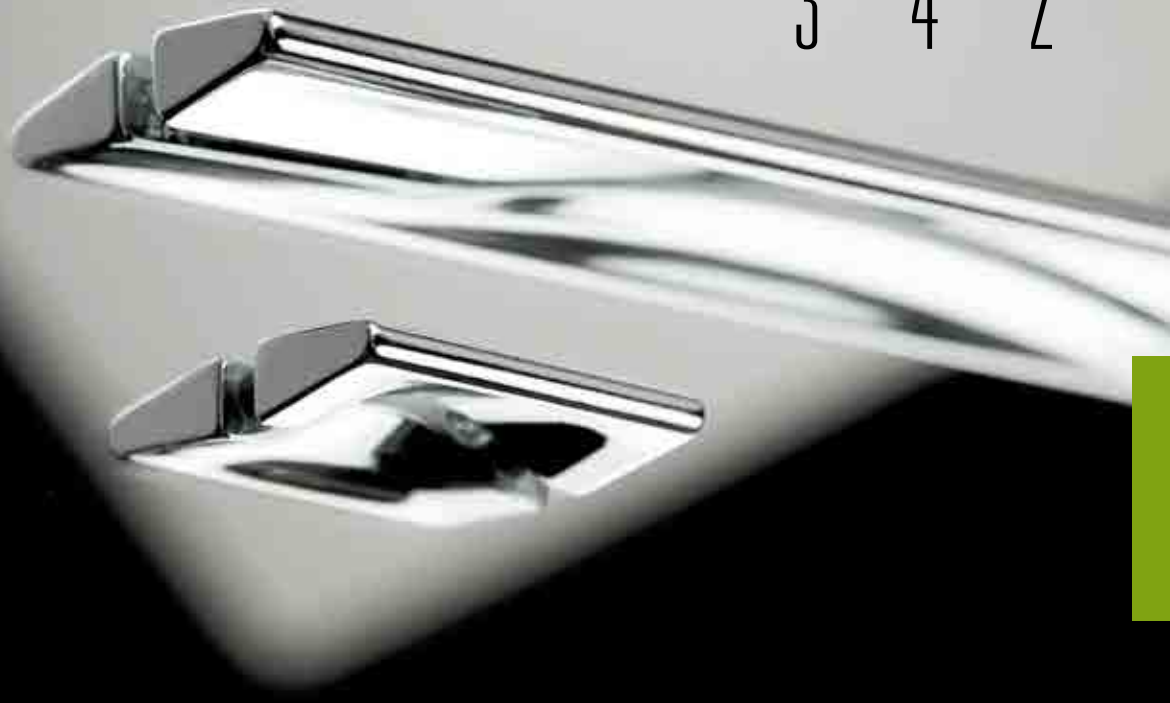

ARTICOLO - ARTICLE	INTERASSE - CENTER DISTANCE
342 A	160
342 A	96
342 B	128
342 B	96
342 C	32

ZAMA / ZAMAK





3 4 4



ARTICOLO - ARTICLE	INTERASSE - CENTER DISTANCE
344	192
344	160

ZAMA / ZAMAK







ARTICOLO - ARTICLE	INTERASSE - CENTER DISTANCE
351 A	160
351 B	96

ZAMA / ZAMAK



3 5 9



ARTICOLO - ARTICLE	INTERASSE - CENTER DISTANCE
359 A	192
359 A	160

ZAMA / ZAMAK





ARTICOLO - ARTICLE	INTERASSE - CENTER DISTANCE
365 B	128
365 B	96

ZAMA / ZAMAK



3 6 6



ARTICOLO - ARTICLE	INTERASSE - CENTER DISTANCE
366 B	192
366 B	160
366 C	96
366 C	64

ZAMA / ZAMAK





ARTICOLO - ARTICLE	INTERASSE - CENTER DISTANCE
<b>381 A</b>	<b>320</b>
<b>381 B</b>	<b>192</b>
<b>381 C</b>	<b>96</b>

ZAMA / ZAMAK



3 8 0

ARTICOLO - ARTICLE

INTERASSE - CENTER DISTANCE

380

96

ZAMA / ZAMAK

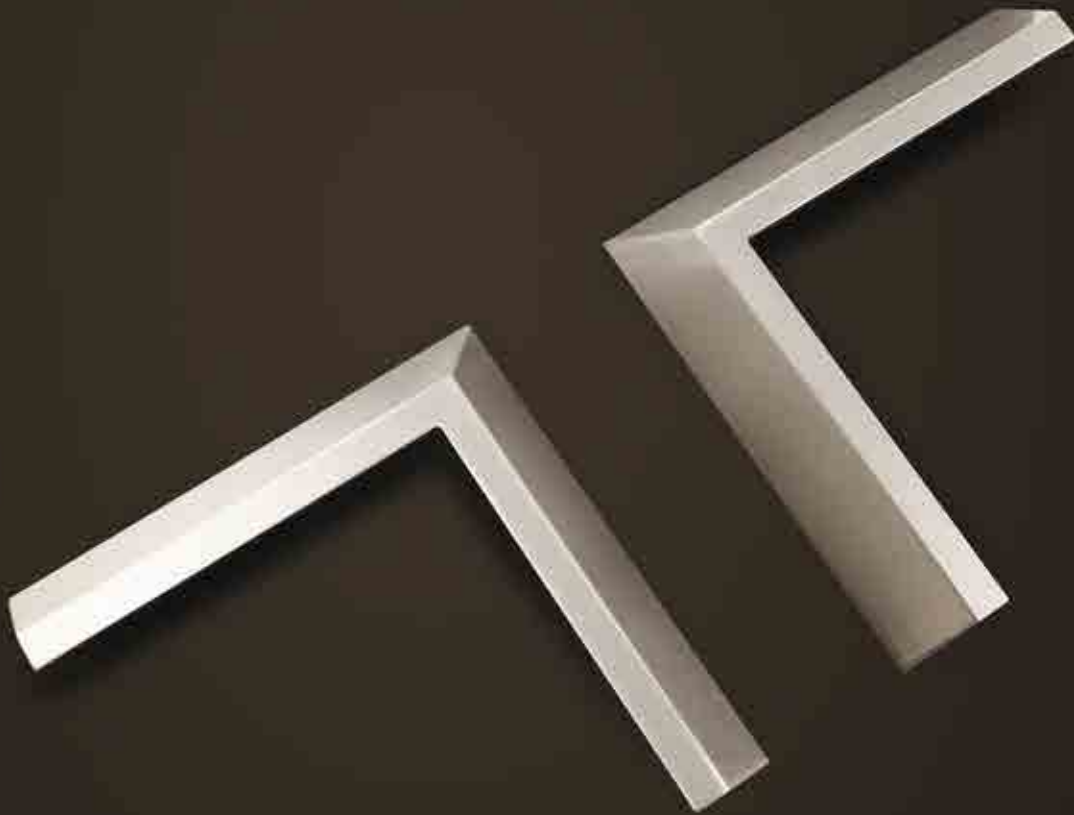

3 9 0



ARTICOLO - ARTICLE	INTERASSE - CENTER DISTANCE
390 B	160
390 C	96

ZAMA / ZAMAK



**citterio**line 

---

**MANIGLIE SERIE QUADRA**  
**SQUARE HANDLES**

2 0 3 6

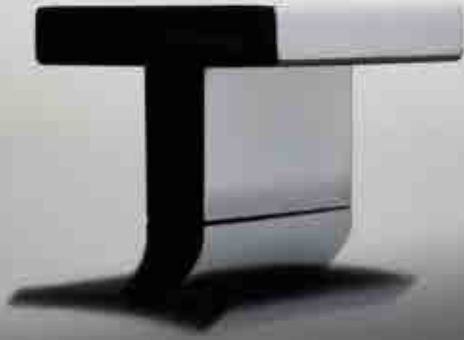

3 3 1



ARTICOLO - ARTICLE	INTERASSE - CENTER DISTANCE
331	192
331	160

ZAMA / ZAMAK





3 3 6



ARTICOLO - ARTICLE

INTERASSE - CENTER DISTANCE

336

32

ZAMA / ZAMAK

2 0 3 3





ARTICOLO - ARTICLE	INTERASSE - CENTER DISTANCE
341	96

ZAMA / ZAMAK

2 0 3 7

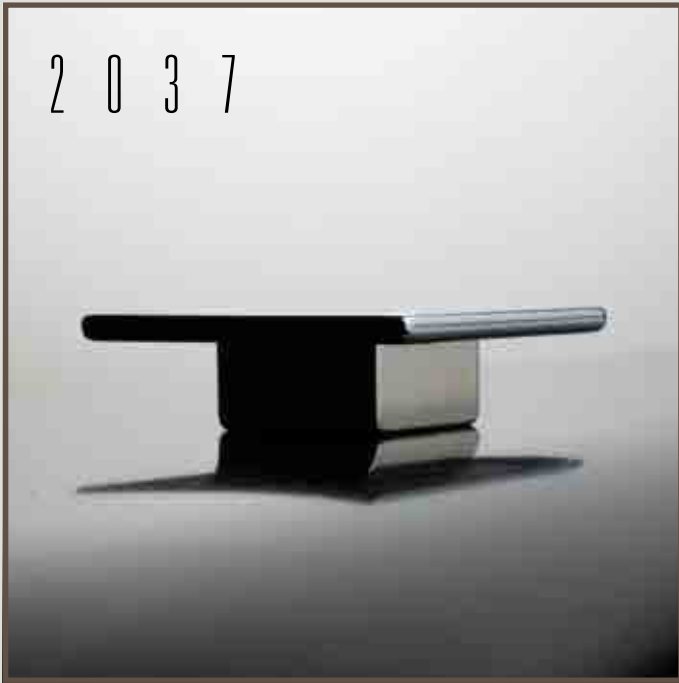

ARTICOLO - ARTICLE	INTERASSE - CENTER DISTANCE
345	96

ZAMA / ZAMAK







ARTICOLO - ARTICLE	INTERASSE - CENTER DISTANCE
348 A	160
348 B	96

ZAMA / ZAMAK





3 5 2



ARTICOLO - ARTICLE	INTERASSE - CENTER DISTANCE
352 A	32
352 B	32

ZAMA / ZAMAK  
ZAMA / ZAMAK - PELLE / LEATHER



3 5 3

ARTICOLO - ARTICLE	INTERASSE - CENTER DISTANCE
353	32

ZAMA / ZAMAK



ARTICOLO - ARTICLE	INTERASSE - CENTER DISTANCE
356	160

ZAMA / ZAMAK





ARTICOLO - ARTICLE INTERASSE - CENTER DISTANCE

361 A 64

ZAMA / ZAMAK



3 7 5



ARTICOLO - ARTICLE	INTERASSE - CENTER DISTANCE
375 A	32
375 B	16

ZAMA / ZAMAK



ARTICOLO - ARTICLE	INTERASSE - CENTER DISTANCE
376 A - K	32
376 B - K	16

ZAMA / ZAMAK - CRISTALLI SWAROVSKI / SWAROVSKI CRYSTALS





ARTICOLO - ARTICLE	INTERASSE - CENTER DISTANCE
378 B	128
378 C	32

ZAMA / ZAMAK



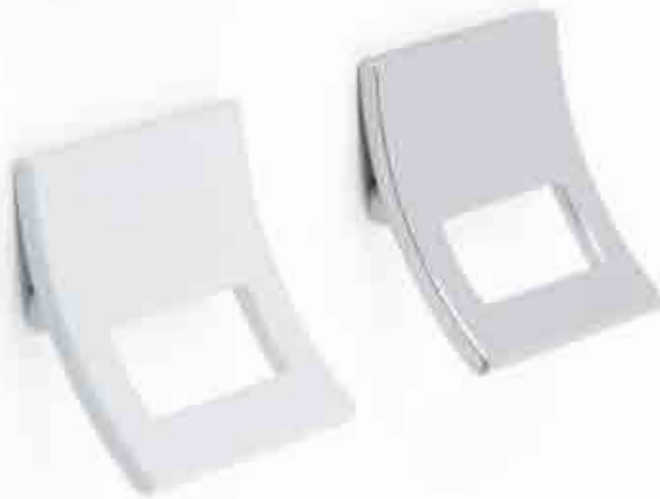



ARTICOLO - ARTICLE	INTERASSE - CENTER DISTANCE
389 B	128
389 C	16

ZAMA / ZAMAK





**citterio**line 

---

**MANIGLIE A INCASSO  
BUILT-IN HANDLES**



ARTICOLO - ARTICLE    INTERASSE - CENTER DISTANCE

307

128

ZAMA / ZAMAK

3 0 7







3 4 9

ARTICOLO - ARTICLE	INTERASSE - CENTER DISTANCE
349 A	120
349 B	96
349 SP	96

ZAMA / ZAMAK





ARTICOLO - ARTICLE      INTERASSE - CENTER DISTANCE

<b>363</b> B	<b>160</b>
<b>363</b> C	<b>64</b>

ZAMA / ZAMAK

3 6 3





ARTICOLO - ARTICLE	INTERASSE - CENTER DISTANCE
374 B	160
374 B	128
374 C	32

ZAMA / ZAMAK

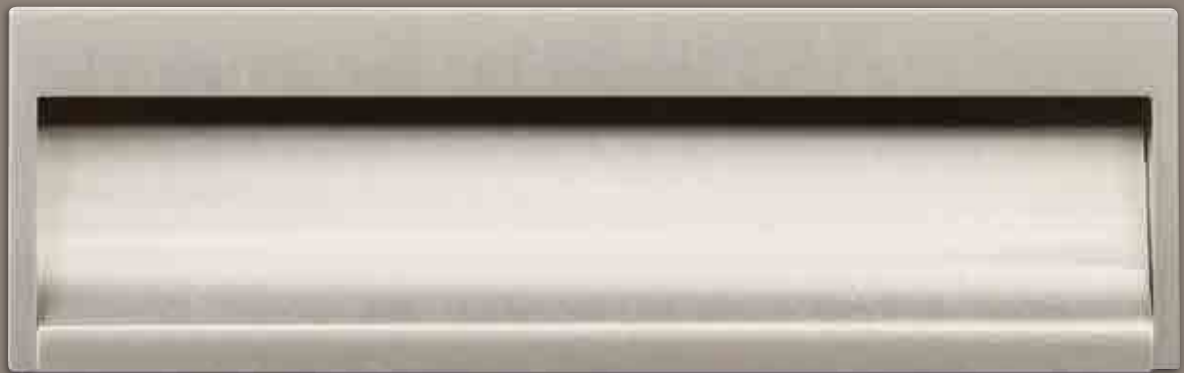

3 8 8

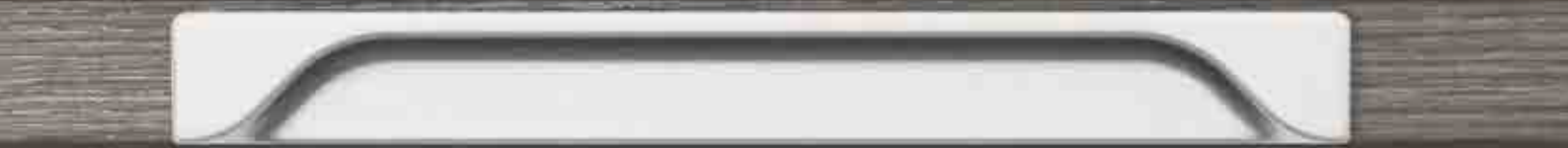

ARTICOLO - ARTICLE    INTERASSE - CENTER DISTANCE

388 B	128
388 C	64

ZAMA / ZAMAK



ARTICOLO - ARTICLE

INTERASSE - CENTER DISTANCE

391

64

ZAMA / ZAMAK





3 9 5



ARTICOLO - ARTICLE      INTERASSE - CENTER DISTANCE

**395** D/S

**32**

ZAMA / ZAMAK

D/S = RIGHT / LEFT



ARTICOLO - ARTICLE    INTERASSE - CENTER DISTANCE

**396** D/S    **128**

ZAMA / ZAMAK

D/S = RIGHT / LEFT

4 0 5



ARTICOLO - ARTICLE    INTERASSE - CENTER DISTANCE

405 B

160

ALLUMINIO-ZAMA / ALUMINIUM-ZAMAK

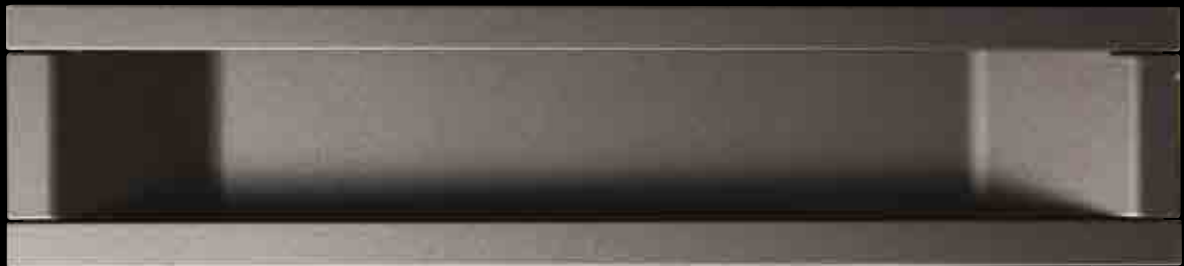

# S 8 0 8 5



ARTICOLO - ARTICLE	INTERASSE - CENTER DISTANCE
<b>S8085 A</b>	<b>170</b>
<b>S8085 B</b>	<b>113</b>

ZAMA / ZAMAK

S 8 1 0 9





ARTICOLO - ARTICLE	INTERASSE - CENTER DISTANCE
<b>S8109</b>	<b>55</b>

ZAMA / ZAMAK









**citterio**line 

---

**MANIGLIE A BARRA E PROFILI  
BAR HANDLES AND PROFILES**

ARTICOLO - ARTICLE

INTERASSE - CENTER DISTANCE

**318**

A RICHIESTA - ON REQUEST

MATERIALE PIEDINO / FOOT MATERIAL: ZAMA / ZAMAK

MATERIALE TUBO / BAR MATERIAL:

OTTONE / BRASS - ACCIAIO / STEEL - ALLUMINIO / ALUMINIUM

3 1 8



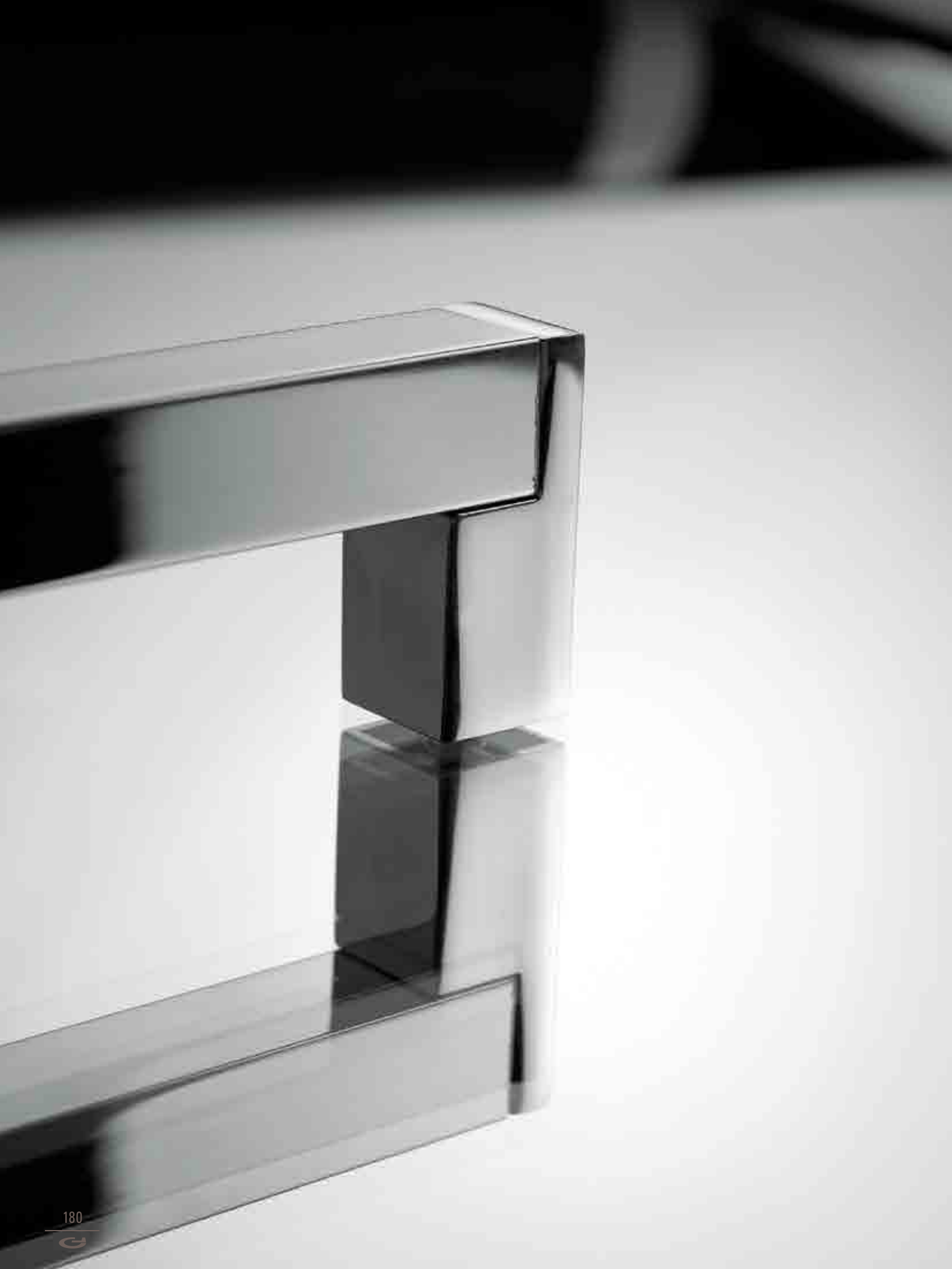

ARTICOLO - ARTICLE

INTERASSE - CENTER DISTANCE

319

A RICHIESTA - ON REQUEST

MATERIALE PIEDINO / FOOT MATERIAL: ZAMA / ZAMAK

MATERIALE TUBO / BAR MATERIAL:

OTTONE / BRASS - ACCIAIO / STEEL - ALLUMINIO / ALUMINIUM



ARTICOLO - ARTICLE

INTERASSE - CENTER DISTANCE

333

A RICHIESTA - ON REQUEST

MATERIALE PIEDINO / FOOT MATERIAL: ZAMA / ZAMAK  
MATERIALE TUBO / BAR MATERIAL: OTTONE / BRASS - ALLUMINIO / ALUMINIUM





3 3 3







3 3 4

ARTICOLO - ARTICLE

INTERASSE - CENTER DISTANCE

334

A RICHIESTA - ON REQUEST

MATERIALE PIEDINO / FOOT MATERIAL: ZAMA / ZAMAK

MATERIALE TUBO / BAR MATERIAL: OTTONE / BRASS - ALLUMINIO / ALUMINIUM

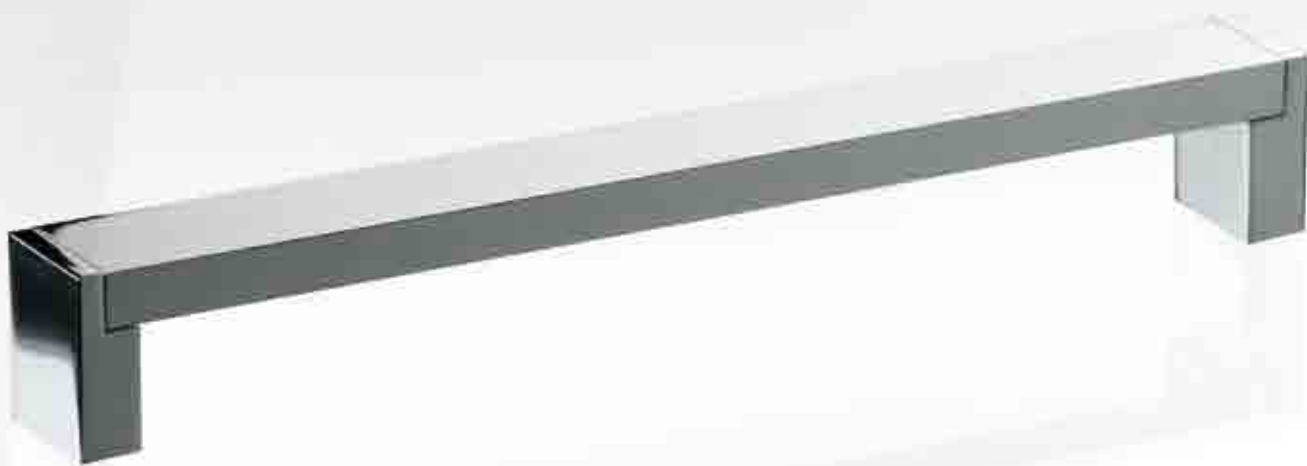

ARTICOLO - ARTICLE

INTERASSE - CENTER DISTANCE

354

A RICHIESTA - ON REQUEST

MATERIALE PIEDINO / FOOT MATERIAL: ZAMA / ZAMAK

MATERIALE TUBO / BAR MATERIAL: FERRO / IRON



3 5 4



ARTICOLO - ARTICLE

INTERASSE - CENTER DISTANCE

358

A RICHIESTA - ON REQUEST

MATERIALE PIEDINO / FOOT MATERIAL: ZAMA / ZAMAK  
MATERIALE TUBO / BAR MATERIAL: OTTONE / BRASS - ALLUMINIO / ALUMINIUM





3 7 1



ARTICOLO - ARTICLE

INTERASSE - CENTER DISTANCE

371

A RICHIESTA - ON REQUEST

MATERIALE PIEDINO / FOOT MATERIAL: ZAMA / ZAMAK

MATERIALE TUBO / BAR MATERIAL: FERRO / IRON

3 7 2



ARTICOLI - ARTICLES	INTERASSE - CENTER DISTANCE
<b>372</b>	A RICHIESTA / ON REQUEST
MATERIALE PIEDINO / FOOT MATERIAL: ZAMA / ZAMAK	
MATERIALE TUBO / BAR MATERIAL: FERRO / IRON	



3 7 3

ARTICOLO - ARTICLE

INTERASSE - CENTER DISTANCE

373

A RICHIESTA - ON REQUEST

MATERIALE PEDINO / FOOT MATERIAL: ZAMA / ZAMAK  
MATERIALE TUBO / BAR MATERIAL: FERRO / IRON



4 0 4

ARTICOLI - ARTICLES INTERASSE - CENTER DISTANCE

404 A RICHIESTA / ON REQUEST

MATERIALE PIEDINO / FOOT MATERIAL: ZAMA / ZAMAK  
MATERIALE TUBO / BAR MATERIAL: FERRO / IRON



5 0 0 0

ARTICOLO - ARTICLE INTERASSE - CENTER DISTANCE  
5000 A RICHIESTA - ON REQUEST  
ALLUMINIO / ALUMINIUM

5 0 0 1

ARTICOLO - ARTICLE INTERASSE - CENTER DISTANCE  
5001 A RICHIESTA - ON REQUEST  
ALLUMINIO / ALUMINIUM

5 0 0 2

ARTICOLO - ARTICLE INTERASSE - CENTER DISTANCE  
5002 A RICHIESTA - ON REQUEST  
ALLUMINIO / ALUMINIUM

5 0 0 3

ARTICOLO - ARTICLE INTERASSE - CENTER DISTANCE  
5003 A RICHIESTA - ON REQUEST  
ALLUMINIO / ALUMINIUM



PROFIL  
PROFILES



**citterio**line 

---

**POMOLI E VARIE  
KNOBS AND VARIOUS HANDLES**

3 0 9



ARTICOLO - ARTICLE	INTERASSE - CENTER DISTANCE
309	32

ZAMA / ZAMAK



3 1 0

ARTICOLO - ARTICLE

INTERASSE - CENTER DISTANCE

310

32

ZAMA / ZAMAK





3 1 1

ARTICOLO - ARTICLE	INTERASSE - CENTER DISTANCE
311	32

ZAMA / ZAMAK



ARTICOLO - ARTICLE

INTERASSE - CENTER DISTANCE

312

FORO CENTRALE / CENTRAL HOLE

ZAMA / ZAMAK

ARTICOLO - ARTICLE

INTERASSE - CENTER DISTANCE

314

FORO CENTRALE / CENTRAL HOLE

ZAMA / ZAMAK



3 1 2



3 1 4

2004

2005

2006



ARTICOLO - ARTICLE	INTERASSE - CENTER DISTANCE
2004	FORO CENTRALE / CENTRAL HOLE
OTTONE / BRASS	

ARTICOLO - ARTICLE	INTERASSE - CENTER DISTANCE
2005	FORO CENTRALE / CENTRAL HOLE
OTTONE / BRASS	

ARTICOLO - ARTICLE	INTERASSE - CENTER DISTANCE
2006	FORO CENTRALE / CENTRAL HOLE
OTTONE / BRASS	

2007



ARTICOLO - ARTICLE	INTERASSE - CENTER DISTANCE
2007	FORO CENTRALE / CENTRAL HOLE
OTTONE / BRASS	

ARTICOLO - ARTICLE INTERASSE - CENTER DISTANCE

2008 FORO CENTRALE / CENTRAL HOLE  
OTTONE / BRASS

2 0 0 8

2 0 0 9

ARTICOLO - ARTICLE INTERASSE - CENTER DISTANCE

2009 FORO CENTRALE / CENTRAL HOLE  
OTTONE / BRASS



ARTICOLO - ARTICLE INTERASSE - CENTER DISTANCE

2010 FORO CENTRALE / CENTRAL HOLE  
OTTONE / BRASS

ARTICOLO - ARTICLE INTERASSE - CENTER DISTANCE

2011 FORO CENTRALE / CENTRAL HOLE  
ZAMA / ZAMAK

2 0 1 0

2 0 1 1



ARTICOLO - ARTICLE INTERASSE - CENTER DISTANCE  
**2035** FORO CENTRALE / CENTRAL HOLE  
OTTONE / BRASS

ARTICOLO - ARTICLE INTERASSE - CENTER DISTANCE  
**2030** FORO CENTRALE / CENTRAL HOLE  
OTTONE / BRASS

ARTICOLO - ARTICLE INTERASSE - CENTER DISTANCE  
**2031** FORO CENTRALE / CENTRAL HOLE  
OTTONE / BRASS

ARTICOLO - ARTICLE INTERASSE - CENTER DISTANCE  
**2034** FORO CENTRALE / CENTRAL HOLE  
OTTONE / BRASS

2 0 3 5

2 0 3 0

2 0 3 1

2 0 3 4



2029

ARTICOLO - ARTICLE

INTERASSE - CENTER DISTANCE

2029

FORO CENTRALE / CENTRAL HOLE

OTTONE / BRASS - LEGNO / WOOD



ARTICOLO - ARTICLE

INTERASSE - CENTER DISTANCE

2038

FORO CENTRALE / CENTRAL HOLE

ZAMA / ZAMAK

2038



ARTICOLO - ARTICLE	INTERASSE - CENTER DISTANCE
<b>S8102</b>	FORO CENTRALE / CENTRAL HOLE OTTONE / BRASS

ARTICOLO - ARTICLE	INTERASSE - CENTER DISTANCE
<b>S8103</b>	FORO CENTRALE / CENTRAL HOLE OTTONE / BRASS



S 8 1 0 2



S 8 1 0 3

2 0 4 2

ARTICOLO - ARTICLE INTERASSE - CENTER DISTANCE

2042 16

ZAMA / ZAMAK



2 0 4 3



ARTICOLO - ARTICLE INTERASSE - CENTER DISTANCE

2043 16

ZAMA / ZAMAK



ARTICOLO - ARTICLE	INTERASSE - CENTER DISTANCE
2036	16

ZAMA / ZAMAK

ARTICOLO - ARTICLE	INTERASSE - CENTER DISTANCE
2033	16

ZAMA / ZAMAK

2 0 3 6



2 0 3 3



ARTICOLO - ARTICLE

INTERASSE - CENTER DISTANCE

2037

16

ZAMA / ZAMAK

2 0 3 7



2 0 3 2

ARTICOLO - ARTICLE INTERASSE - CENTER DISTANCE

2032 16

ZAMA / ZAMAK



ARTICOLO - ARTICLE INTERASSE - CENTER DISTANCE

2045 16

ZAMA / ZAMAK

2 0 4 5



ARTICOLO - ARTICLE	INTERASSE - CENTER DISTANCE
2041 B	32
2041 C	32

ZAMA / ZAMAK

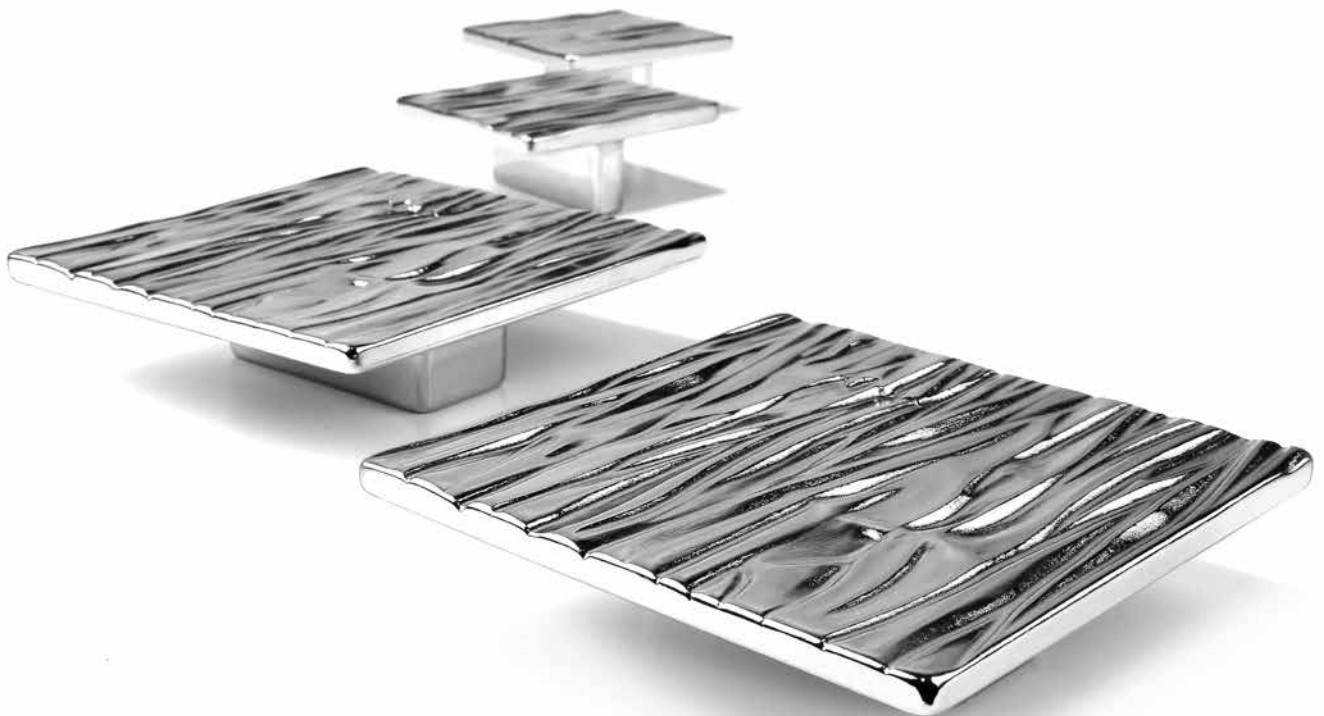

2 0 4 8



ARTICOLO - ARTICLE	INTERASSE - CENTER DISTANCE
2048	32

ZAMA / ZAMAK

2 0 4 9



ARTICOLO - ARTICLE

INTERASSE - CENTER DISTANCE

2049 K

FORO CENTRALE / CENTRAL HOLE

OTTONE / BRASS - CRISTALLI SWAROVSKI / SWAROVSKI CRYSTALS

2 0 5 2



2052 A	FORO CENTRALE / CENTRAL HOLE
2052 B	FORO CENTRALE / CENTRAL HOLE







**citterio**line 

---

**MANIGLIE E POMOLI IN STILE  
CLASSIC HANDLES AND KNOBS**

2 0 2 7



ARTICOLO - ARTICLE INTERASSE - CENTER DISTANCE

2027 FORO CENTRALE / CENTRAL HOLE

ZAMA / ZAMAK

2 0 2 8



2 0 2 7



ARTICOLO - ARTICLE INTERASSE - CENTER DISTANCE

1017 96

ZAMA / ZAMAK - PLASTICA / PLASTIC





ARTICOLO - ARTICLE	INTERASSE - CENTER DISTANCE
1018	128
ZAMA / ZAMAK - PLASTICA / PLASTIC	



ARTICOLO - ARTICLE	INTERASSE - CENTER DISTANCE
2028	FORO CENTRALE / CENTRAL HOLE
ZAMA / ZAMAK	

2 0 3 9



ARTICOLO - ARTICLE	INTERASSE - CENTER DISTANCE
2039	16

ZAMA / ZAMAK

1 0 1 9

ARTICOLO - ARTICLE	INTERASSE - CENTER DISTANCE
1019 B	128
1019 c	96

ZAMA / ZAMAK





2 0 4 0



ARTICOLO - ARTICLE	INTERASSE - CENTER DISTANCE
2040	16

ZAMA / ZAMAK

1 0 2 0

ARTICOLO - ARTICLE	INTERASSE - CENTER DISTANCE
1020 B	128
1020 C	96

ZAMA / ZAMAK





ARTICOLO - ARTICLE INTERASSE - CENTER DISTANCE

1021 A	160
1021 A - K	160
1021	96
1021 K	96

ZAMA / ZAMAK - CRISTALLI SWAROVSKI / SWAROVSKI CRYSTALS

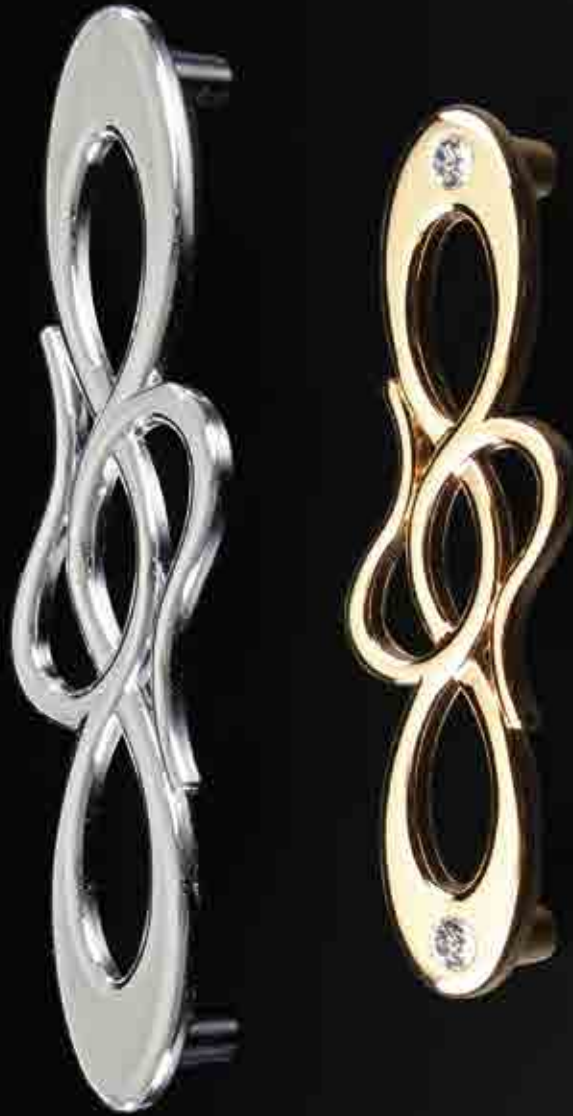

2 0 4 4



ARTICOLO - ARTICLE	INTERASSE - CENTER DISTANCE
2044	FORO CENTRALE / CENTRAL HOLE
2044 K	FORO CENTRALE / CENTRAL HOLE

ZAMA / ZAMAK - CRISTALLI SWAROVSKI / SWAROVSKI CRYSTALS



ARTICOLO - ARTICLE

INTERASSE - CENTER DISTANCE

1022

96

ZAMA / ZAMAK



1 0 2 3

ARTICOLO - ARTICLE	INTERASSE - CENTER DISTANCE
1023	96

ZAMA / ZAMAK



1 0 2 4



ARTICOLO - ARTICLE	INTERASSE - CENTER DISTANCE
1024 B	96

ZAMA / ZAMAK



2 0 4 6



ARTICOLO - ARTICLE	INTERASSE - CENTER DISTANCE
2046	16

ZAMA / ZAMAK

1 0 2 5



ARTICOLO - ARTICLE	INTERASSE - CENTER DISTANCE
1025 B	128
1025 C	96

ZAMA / ZAMAK



1 0 2 6



ARTICOLO - ARTICLE	INTERASSE - CENTER DISTANCE
1026 B	128
1026 C	96

ZAMA / ZAMAK

1 0 2 7

ARTICOLO - ARTICLE	INTERASSE - CENTER DISTANCE
1027 B - K	160
1027 C - K	96

ZAMA / ZAMAK - CRISTALLI SWAROVSKI / SWAROVSKI CRYSTALS



2 0 4 7

ARTICOLO - ARTICLE INTERASSE - CENTER DISTANCE

2047 κ FORO CENTRALE / CENTRAL HOLE

ZAMA / ZAMAK - CRISTALLI SWAROVSKI / SWAROVSKI CRYSTALS



1 0 2 8



ARTICOLO - ARTICLE INTERASSE - CENTER DISTANCE

1028 B	128
1028 C	96

ZAMA / ZAMAK

2 0 5 0

ARTICOLO - ARTICLE INTERASSE - CENTER DISTANCE

2050	FORO CENTRALE / CENTRAL HOLE
------	------------------------------

ZAMA / ZAMAK



1 0 2 9



ARTICOLO - ARTICLE INTERASSE - CENTER DISTANCE

1029 B	128
1029 C	96

ZAMA / ZAMAK

2 0 5 1

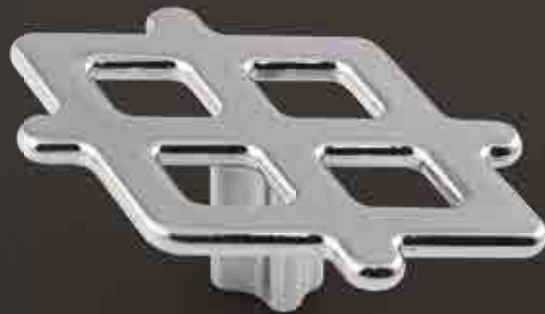

ARTICOLO - ARTICLE

INTERASSE - CENTER DISTANCE

2051

FORO CENTRALE / CENTRAL HOLE

ZAMA / ZAMAK

1 0 3 0

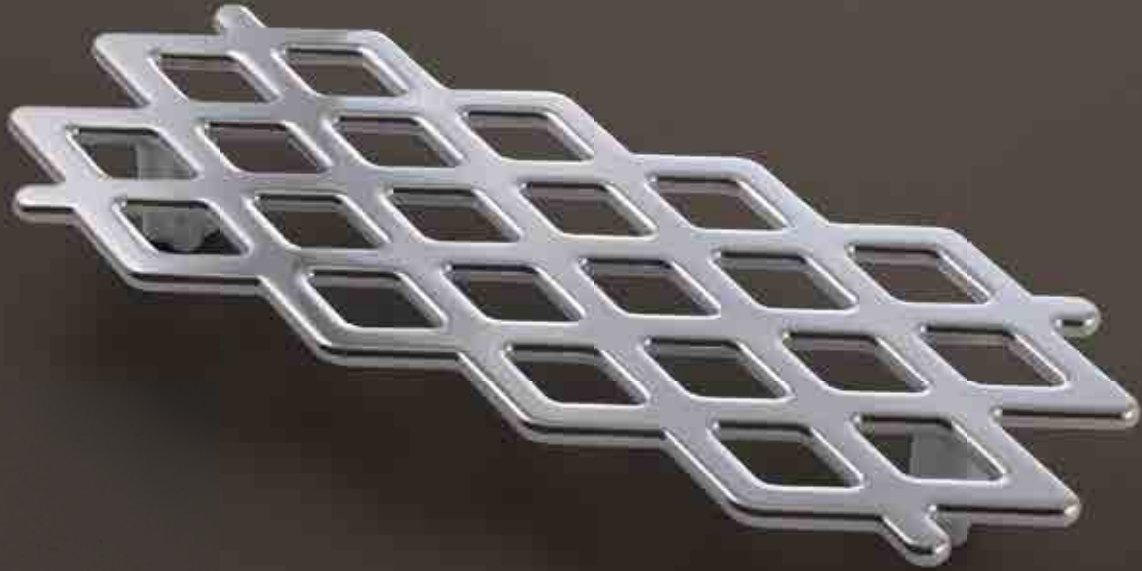

ARTICOLO - ARTICLE    INTERASSE - CENTER DISTANCE

1030 B    128

ZAMA / ZAMAK

1 0 3 1



ARTICOLO - ARTICLE    INTERASSE - CENTER DISTANCE

1031 B    96

ZAMA / ZAMAK



2 0 5 3



ARTICOLO - ARTICLE

INTERASSE - CENTER DISTANCE

2053

FORO CENTRALE / CENTRAL HOLE

ZAMA / ZAMAK

1 0 3 2



ARTICOLO - ARTICLE INTERASSE - CENTER DISTANCE

1032 c

96

ZAMA / ZAMAK

S 8 0 8 7



ARTICOLO - ARTICLE	INTERASSE - CENTER DISTANCE
S8087	96

ZAMA / ZAMAK

# S 8 1 0 5

ARTICOLO - ARTICLE INTERASSE - CENTER DISTANCE

S8105 FORO CENTRALE / CENTRAL HOLE

S8105 K FORO CENTRALE / CENTRAL HOLE

ZAMA / ZAMAK - CRISTALLI SWAROVSKI / SWAROVSKI CRYSTALS



S 8 1 0 7



ARTICOLO - ARTICLE	INTERASSE - CENTER DISTANCE
S8107	128

ZAMA / ZAMAK

S 8 1 0 8



ARTICOLO - ARTICLE	INTERASSE - CENTER DISTANCE
S8108	128

ZAMA / ZAMAK



2014



2024



2021



2023



ARTICOLO - ARTICLE	INTERASSE - CENTER DISTANCE
2014 B	FORO CENTRALE / CENTRAL HOLE
2014 C	FORO CENTRALE / CENTRAL HOLE

ZAMA / ZAMAK

ARTICOLO - ARTICLE	INTERASSE - CENTER DISTANCE
2024	FORO CENTRALE / CENTRAL HOLE

ZAMA / ZAMAK

ARTICOLO - ARTICLE	INTERASSE - CENTER DISTANCE
2021 B	FORO CENTRALE / CENTRAL HOLE
2021 C	FORO CENTRALE / CENTRAL HOLE

ZAMA / ZAMAK

ARTICOLO - ARTICLE	INTERASSE - CENTER DISTANCE
2023 B	FORO CENTRALE / CENTRAL HOLE
2023 C	FORO CENTRALE / CENTRAL HOLE

ZAMA / ZAMAK



2022



2025

ARTICOLO - ARTICLE    INTERASSE - CENTER DISTANCE  
2022    FORO CENTRALE / CENTRAL HOLE  
ZAMA / ZAMAK

ARTICOLO - ARTICLE    INTERASSE - CENTER DISTANCE  
2025    FORO CENTRALE / CENTRAL HOLE  
ZAMA / ZAMAK

ARTICOLO - ARTICLE    INTERASSE - CENTER DISTANCE  
2026    FORO CENTRALE / CENTRAL HOLE  
OTTONE / BRASS



2026





**citterio**line 

---

# TECHNICAL

301

pag. 108

ARTICOLO ARTICLE	C INTERASSE CENTER DISTANCE	X LUNGHEZZA TOTALE TOTAL LENGTH	Z LARGHEZZA WIDTH	Y ALTEZZA HEIGHT
301 A	192	202	15	20
301 B	128	138	15	20

MATERIALE - MATERIAL zama / zamak

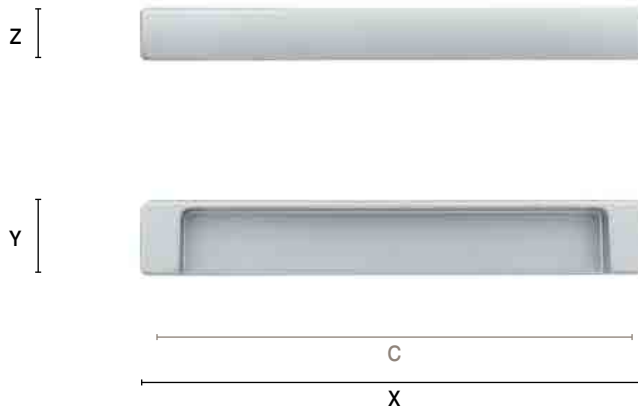

302

pag. 14

ARTICOLO ARTICLE	C INTERASSE CENTER DISTANCE	X LUNGHEZZA TOTALE TOTAL LENGTH	Z LARGHEZZA WIDTH	Y ALTEZZA HEIGHT
302 A	160	176	9	36
302 c	96	110	9	32

MATERIALE - MATERIAL zama / zamak

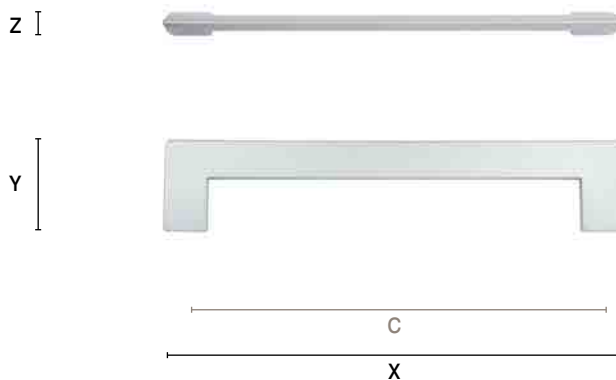

303

pag. 16

ARTICOLO ARTICLE	C INTERASSE CENTER DISTANCE	X LUNGHEZZA TOTALE TOTAL LENGTH	Z LARGHEZZA WIDTH	Y ALTEZZA HEIGHT
303 A	192	203	30	30
303 B	160	170	28	28
303 c	128	137	22	25

MATERIALE - MATERIAL zama / zamak

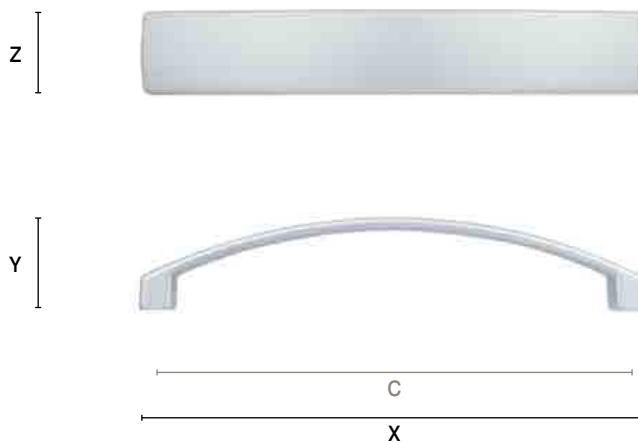

304

pag. 18

ARTICOLO ARTICLE	C INTERASSE CENTER DISTANCE	X LUNGHEZZA TOTALE TOTAL LENGTH	Z LARGHEZZA WIDTH	Y ALTEZZA HEIGHT
<b>304</b>	<b>224</b>	240	10	37

MATERIALE - MATERIAL zama / zamak

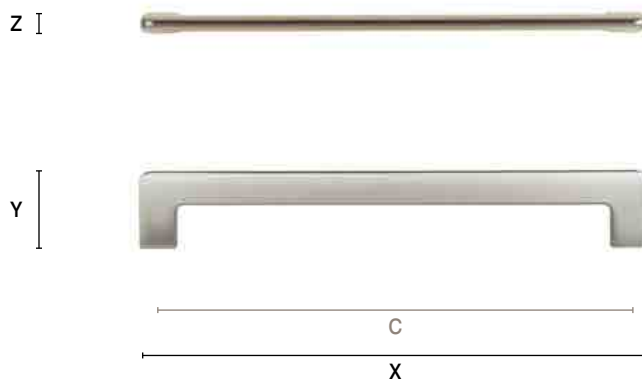

305

pag. 20

ARTICOLO ARTICLE	C INTERASSE CENTER DISTANCE	X LUNGHEZZA TOTALE TOTAL LENGTH	Z LARGHEZZA WIDTH	Y ALTEZZA HEIGHT
<b>305</b>	<b>160</b>	230	25	28

MATERIALE - MATERIAL zama / zamak

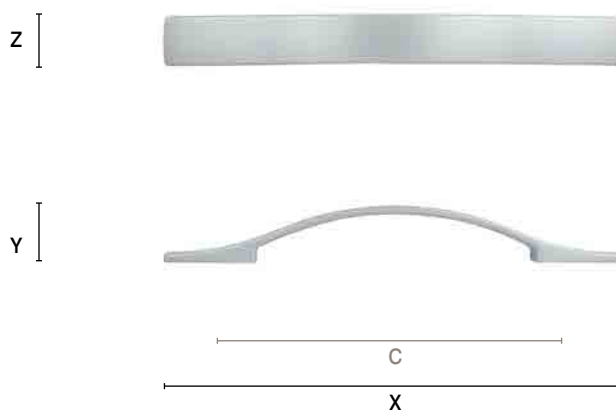

306

pag. 24

ARTICOLO ARTICLE	C INTERASSE CENTER DISTANCE	X LUNGHEZZA TOTALE TOTAL LENGTH	Z LARGHEZZA WIDTH	Y ALTEZZA HEIGHT
<b>306</b>	<b>160</b>	185	28	34

MATERIALE - MATERIAL zama / zamak

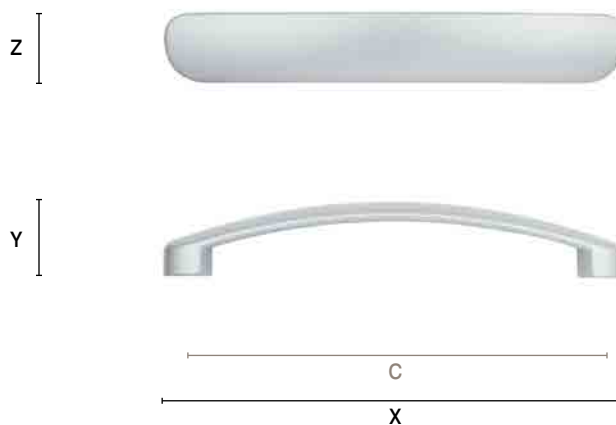

307

pag. 158

ARTICOLO ARTICLE	C INTERASSE CENTER DISTANCE	X LUNGHEZZA TOTALE TOTAL LENGTH	Z LARGHEZZA WIDTH	Y ALTEZZA HEIGHT
307	128	144	43	20

MATERIALE - MATERIAL zama / zamak

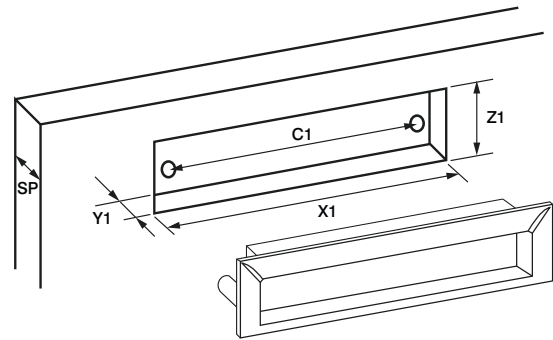
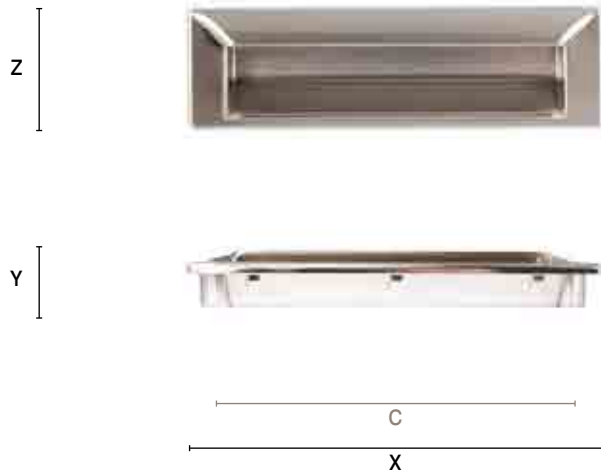

<b>SP</b>	MINIMO SPESSORE ANTA PER MONTAGGIO MINIMUM DOOR DEPTH	16
<b>C1</b>	INTERASSE CENTER DISTANCE	128
<b>X1</b>	LUNGHEZZA FRESATA TOTAL LENGTH OF THE DOOR GROOVE	140
<b>Z1</b>	LARGHEZZA FRESATA TOTAL WIDTH OF THE DOOR GROOVE	38
<b>Y1</b>	ALTEZZA FRESATA TOTAL HEIGHT OF THE DOOR GROOVE	14

308

pag. 26

ARTICOLO ARTICLE	C INTERASSE CENTER DISTANCE	X LUNGHEZZA TOTALE TOTAL LENGTH	Z LARGHEZZA WIDTH	Y ALTEZZA HEIGHT
308	160	169	24	26

MATERIALE - MATERIAL zama / zamak

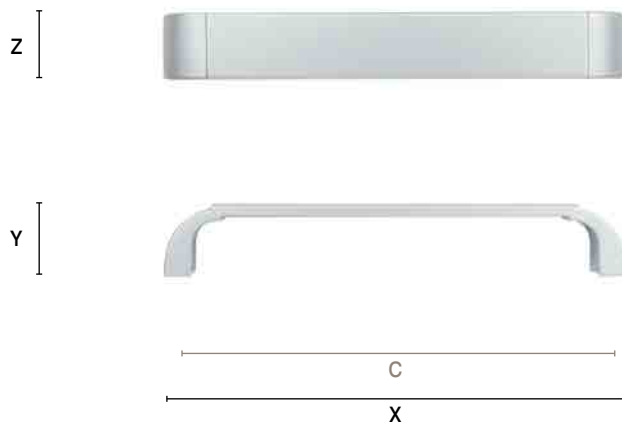

309

pag. 198

ARTICOLO ARTICLE	C INTERASSE CENTER DISTANCE	X LUNGHEZZA TOTALE TOTAL LENGTH	Z LARGHEZZA WIDTH	Y ALTEZZA HEIGHT
<b>309</b>	<b>32</b>	42	10	21

MATERIALE - MATERIAL zama / zamak

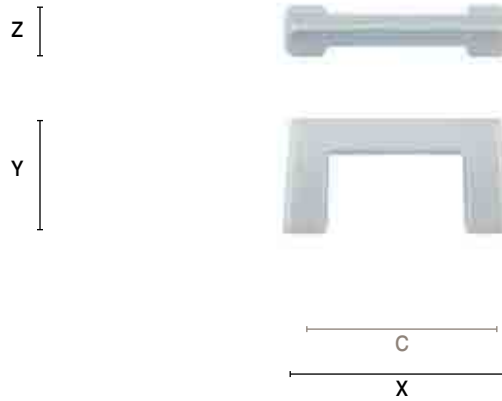

310

pag. 199

ARTICOLO ARTICLE	C INTERASSE CENTER DISTANCE	X LUNGHEZZA TOTALE TOTAL LENGTH	Z LARGHEZZA WIDTH	Y ALTEZZA HEIGHT
<b>310</b>	<b>32</b>	40	15	19

MATERIALE - MATERIAL zama / zamak

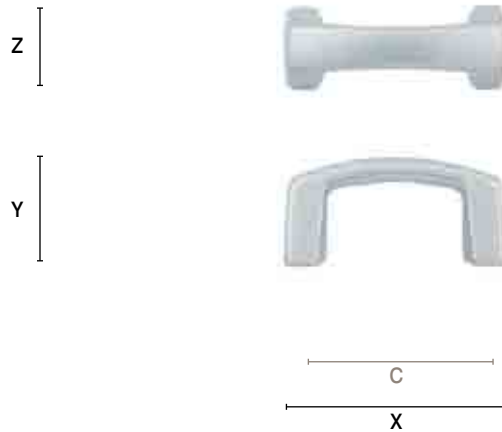

311

pag. 200

ARTICOLO ARTICLE	C INTERASSE CENTER DISTANCE	X LUNGHEZZA TOTALE TOTAL LENGTH	Z LARGHEZZA WIDTH	Y ALTEZZA HEIGHT
<b>311</b>	<b>32</b>	40	13	19

MATERIALE - MATERIAL zama / zamak

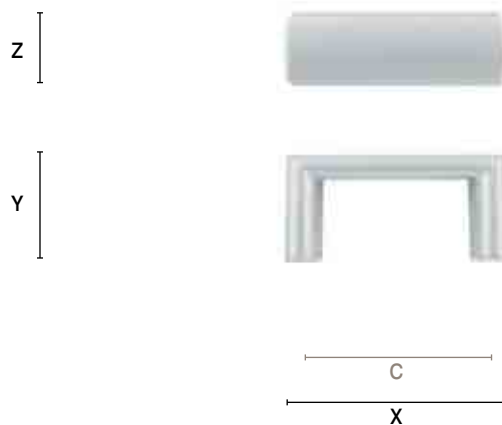

312

pag. 201

ARTICOLO ARTICLE	C INTERASSE CENTER DISTANCE	X LUNGHEZZA TOTALE TOTAL LENGTH	Z LARGHEZZA WIDTH	Y ALTEZZA HEIGHT
<b>312</b>	FORO CENTRALE / CENTRAL HOLE	21	21	21

MATERIALE - MATERIAL zama / zamak

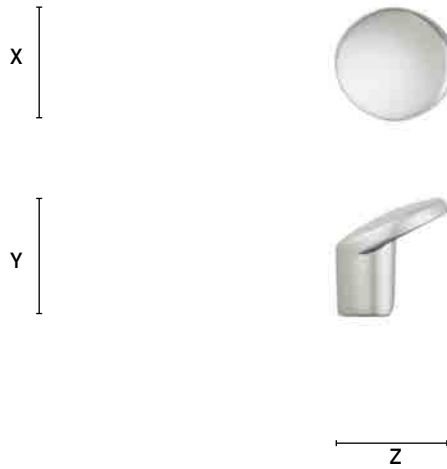

313

pag. 110

ARTICOLO ARTICLE	C INTERASSE CENTER DISTANCE	X LUNGHEZZA TOTALE TOTAL LENGTH	Z LARGHEZZA WIDTH	Y ALTEZZA HEIGHT
<b>313 A</b>	<b>160</b>	177	20	10
<b>313 B</b>	<b>128</b>	141	20	10
<b>313 B</b>	<b>64</b>	141	20	10
<b>313 C</b>	<b>96</b>	111	20	10
<b>313 C</b>	<b>64</b>	111	20	10
<b>313 D</b>	<b>16</b>	29	20	10
<b>313 D</b>	FORO CENTRALE / CENTRAL HOLE	29	20	10

MATERIALE - MATERIAL zama / zamak

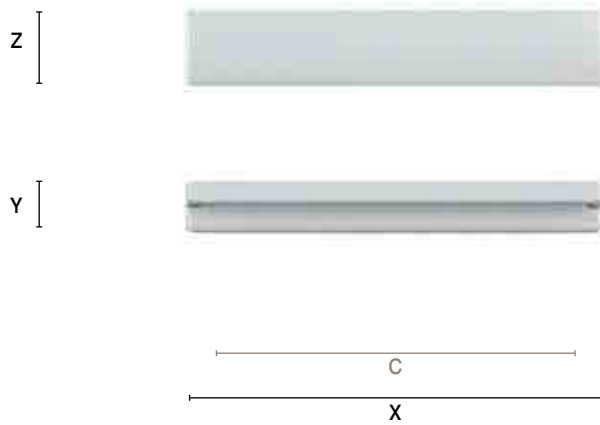

314

pag. 201

ARTICOLO ARTICLE	C INTERASSE CENTER DISTANCE	X LUNGHEZZA TOTALE TOTAL LENGTH	Z LARGHEZZA WIDTH	Y ALTEZZA HEIGHT
<b>314</b>	FORO CENTRALE / CENTRAL HOLE	17	28	19

MATERIALE - MATERIAL zama / zamak

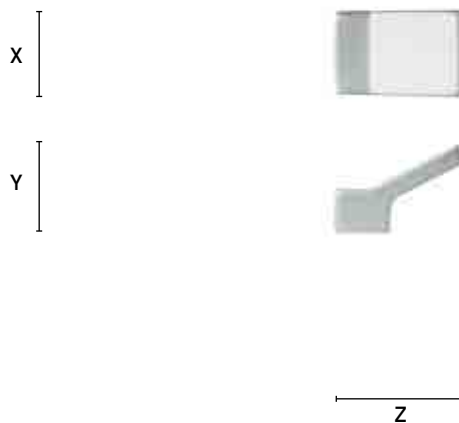

315

pag. 28

ARTICOLO ARTICLE	C INTERASSE CENTER DISTANCE	X LUNGHEZZA TOTALE TOTAL LENGTH	Z LARGHEZZA WIDTH	Y ALTEZZA HEIGHT
315 A	192	207	28	30
315 B	160	175	28	30
315 C	96	113	26	28

MATERIALE - MATERIAL zama / zamak

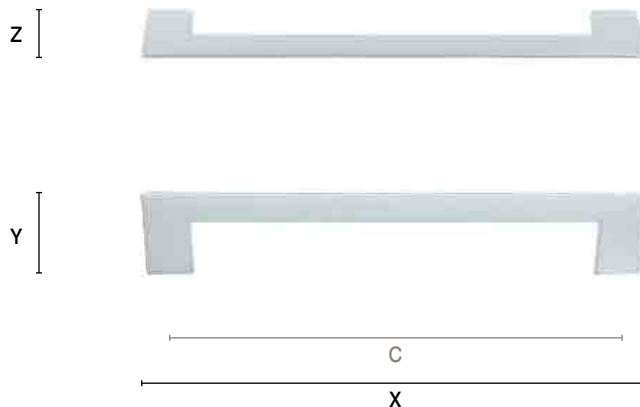

316

pag. 112

ARTICOLO ARTICLE	C INTERASSE CENTER DISTANCE	X LUNGHEZZA TOTALE TOTAL LENGTH	Z LARGHEZZA WIDTH	Y ALTEZZA HEIGHT
316	128	140	20	20
316	96	140	20	20

MATERIALE - MATERIAL zama / zamak

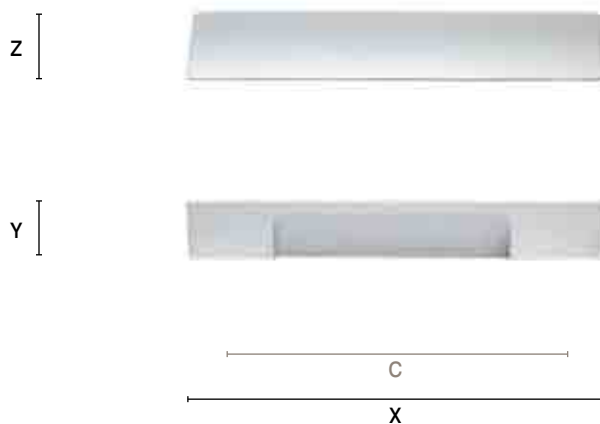

317

pag. 113

ARTICOLO ARTICLE	C INTERASSE CENTER DISTANCE	X LUNGHEZZA TOTALE TOTAL LENGTH	Z LARGHEZZA WIDTH	Y ALTEZZA HEIGHT
317	32	43	20	20

MATERIALE - MATERIAL zama / zamak

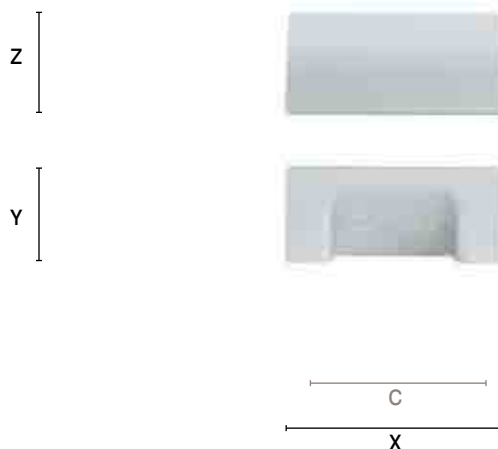



318

pag. 178

ARTICOLO ARTICLE	C INTERASSE CENTER DISTANCE	X LUNGHEZZA TOTALE TOTAL LENGTH	Z LARGHEZZA WIDTH	Y ALTEZZA HEIGHT
<b>318</b>	A RICHIESTA / ON REQUEST	-	15	37

MATERIALE PIEDINO - FOOT MATERIAL zama / zamak

MATERIALE TUBO - BAR MATERIAL ottone / brass - acciaio / steel - alluminio / aluminium

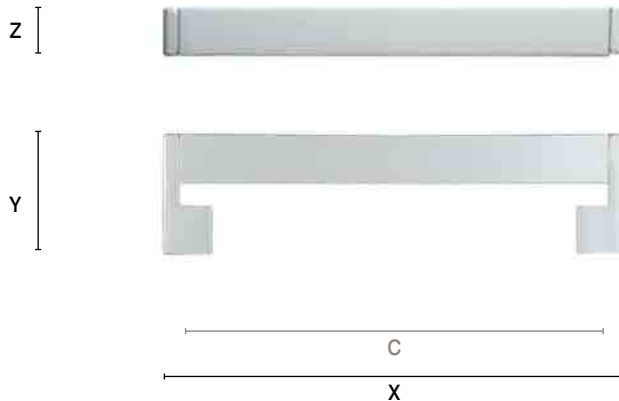

319

pag. 180

ARTICOLO ARTICLE	C INTERASSE CENTER DISTANCE	X LUNGHEZZA TOTALE TOTAL LENGTH	Z LARGHEZZA WIDTH	Y ALTEZZA HEIGHT
<b>319</b>	A RICHIESTA / ON REQUEST	-	15	37

MATERIALE PIEDINO - FOOT MATERIAL zama / zamak

MATERIALE TUBO - BAR MATERIAL ottone / brass - acciaio / steel - alluminio / aluminium

versione portasalvietta / towel holder

ARTICOLO ARTICLE	C INTERASSE CENTER DISTANCE	X LUNGHEZZA TOTALE TOTAL LENGTH	Z LARGHEZZA WIDTH	Y ALTEZZA HEIGHT
<b>319</b>	A RICHIESTA / ON REQUEST	-	15	55

MATERIALE PIEDINO - FOOT MATERIAL zama / zamak

MATERIALE TUBO - BAR MATERIAL ottone / brass - acciaio / steel - alluminio / aluminium

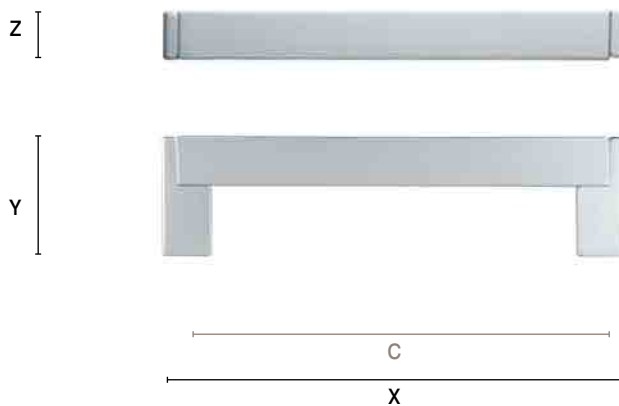

322

pag. 30

ARTICOLO ARTICLE	C INTERASSE CENTER DISTANCE	X LUNGHEZZA TOTALE TOTAL LENGTH	Z LARGHEZZA WIDTH	Y ALTEZZA HEIGHT
<b>322 A</b>	<b>160</b>	171	21	21
<b>322 B</b>	<b>128</b>	140	21	21
<b>322 C</b>	<b>32</b>	40	21	21

MATERIALE - MATERIAL zama / zamak

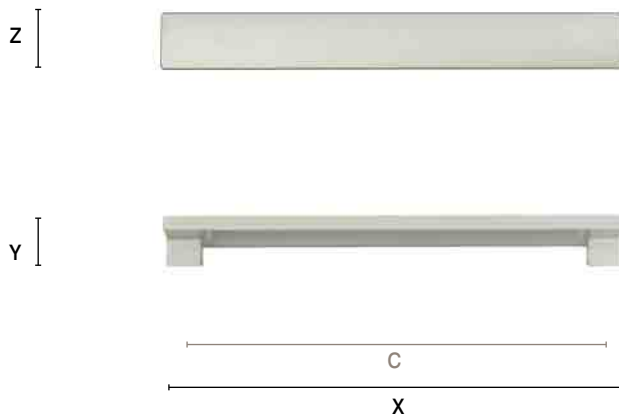

323

pag. 32

ARTICOLO ARTICLE	C INTERASSE CENTER DISTANCE	X LUNGHEZZA TOTALE TOTAL LENGTH	Z LARGHEZZA WIDTH	Y ALTEZZA HEIGHT
<b>323</b>	<b>224</b>	235	21	21
<b>323</b>	<b>192</b>	235	21	21

MATERIALE - MATERIAL zama / zamak

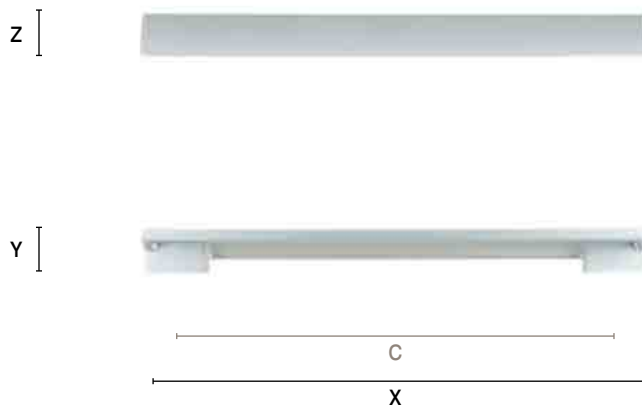

324

pag. 34

ARTICOLO ARTICLE	C INTERASSE CENTER DISTANCE	X LUNGHEZZA TOTALE TOTAL LENGTH	Z LARGHEZZA WIDTH	Y ALTEZZA HEIGHT
<b>324</b>	<b>32</b>	60	25	12

MATERIALE - MATERIAL zama / zamak

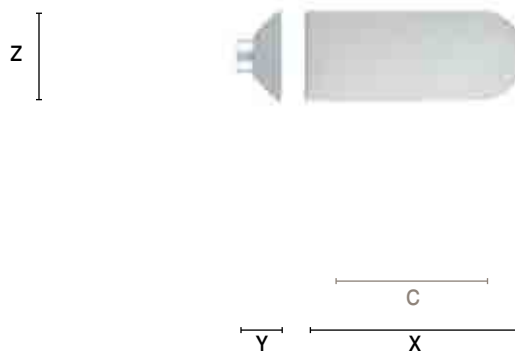

325

pag. 114

ARTICOLO ARTICLE	C INTERASSE CENTER DISTANCE	X LUNGHEZZA TOTALE TOTAL LENGTH	Z LARGHEZZA WIDTH	Y ALTEZZA HEIGHT
<b>325</b>	<b>192</b>	204	21	21
<b>325</b>	<b>160</b>	204	21	21

MATERIALE - MATERIAL zama / zamak

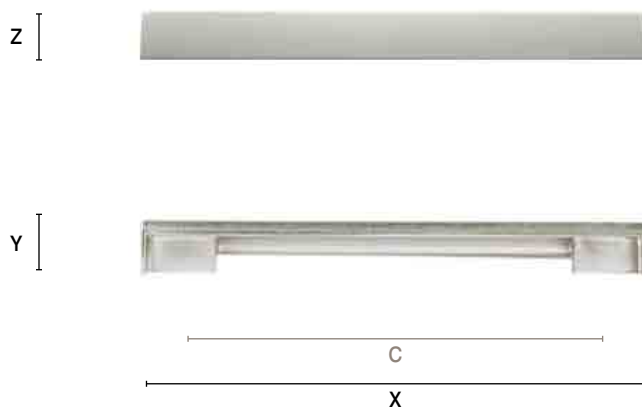

326

pag. 116

ARTICOLO ARTICLE	C INTERASSE CENTER DISTANCE	X LUNGHEZZA TOTALE TOTAL LENGTH	Z LARGHEZZA WIDTH	Y ALTEZZA HEIGHT
326 B	96	110	7	15
326 B	64	110	7	15
326 C	16	30	7	15
326 C	FORO CENTRALE / CENTRAL HOLE	30	7	15

MATERIALE - MATERIAL zama / zamak

z



y

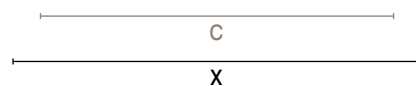

327

pag. 38

ARTICOLO ARTICLE	C INTERASSE CENTER DISTANCE	X LUNGHEZZA TOTALE TOTAL LENGTH	Z LARGHEZZA WIDTH	Y ALTEZZA HEIGHT
327 A	192	205	10	20
327 A	160	205	10	20
327 B	128	140	10	20
327 B	96	140	10	20

MATERIALE - MATERIAL zama / zamak

z



y

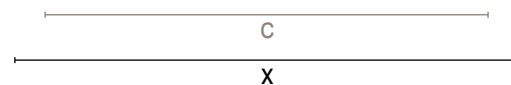

328

pag. 42

ARTICOLO ARTICLE	C INTERASSE CENTER DISTANCE	X LUNGHEZZA TOTALE TOTAL LENGTH	Z LARGHEZZA WIDTH	Y ALTEZZA HEIGHT
328	192	216	23	25
328	160	216	23	25

MATERIALE - MATERIAL zama / zamak

z



y

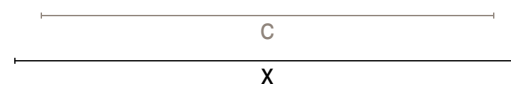

329

pag. 36

ARTICOLO ARTICLE	C INTERASSE CENTER DISTANCE	X LUNGHEZZA TOTALE TOTAL LENGTH	Z LARGHEZZA WIDTH	Y ALTEZZA HEIGHT
<b>329</b>	<b>160</b>	185	25	18
<b>329 SP</b>	<b>160</b>	185	25	12

MATERIALE - MATERIAL zama / zamak

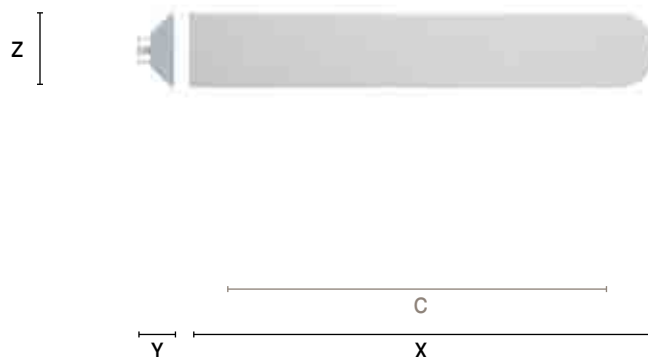

330

pag. 44

ARTICOLO ARTICLE	C INTERASSE CENTER DISTANCE	X LUNGHEZZA TOTALE TOTAL LENGTH	Z LARGHEZZA WIDTH	Y ALTEZZA HEIGHT
<b>330</b>	<b>192</b>	205	26	23
<b>330</b>	<b>160</b>	205	26	23

MATERIALE - MATERIAL zama / zamak

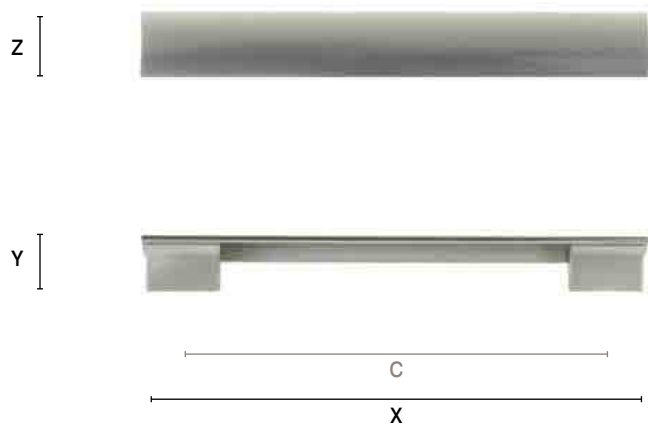

331

pag. 134

ARTICOLO ARTICLE	C INTERASSE CENTER DISTANCE	X LUNGHEZZA TOTALE TOTAL LENGTH	Z LARGHEZZA WIDTH	Y ALTEZZA HEIGHT
<b>331</b>	<b>192</b>	218	34	24
<b>331</b>	<b>160</b>	218	34	24

MATERIALE - MATERIAL zama / zamak

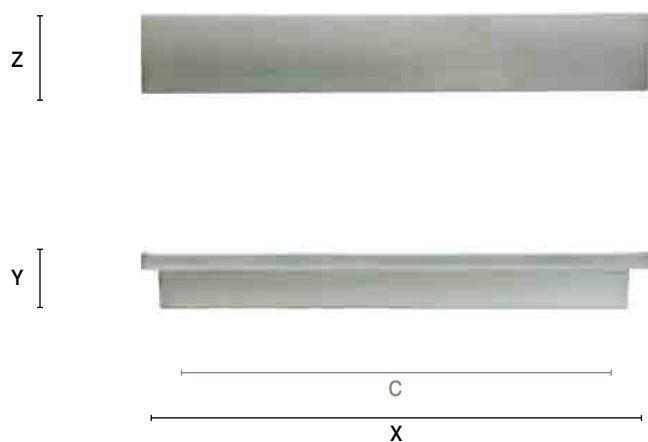

332

pag. 46

ARTICOLO ARTICLE	C INTERASSE CENTER DISTANCE	X LUNGHEZZA TOTALE TOTAL LENGTH	Z LARGHEZZA WIDTH	Y ALTEZZA HEIGHT
332 A	160	170	21	28
332 B	128	138	20	28

MATERIALE - MATERIAL zama / zamak

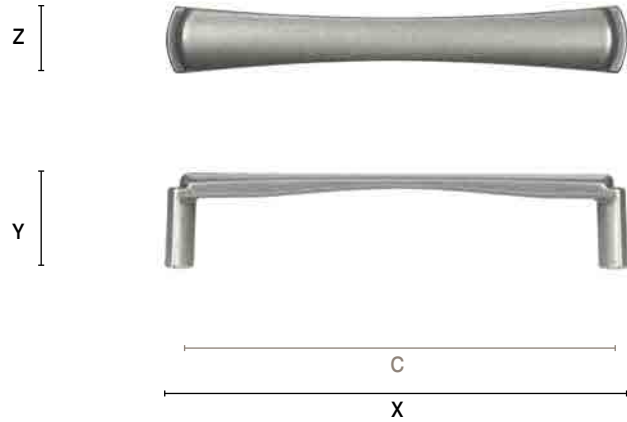

333

pag. 182

ARTICOLO ARTICLE	C INTERASSE CENTER DISTANCE	X LUNGHEZZA TOTALE TOTAL LENGTH	Z LARGHEZZA WIDTH	Y ALTEZZA HEIGHT
333	A RICHIESTA / ON REQUEST	-	25	35

MATERIALE PIEDINO - FOOT MATERIAL zama / zamak

MATERIALE TUBO - BAR MATERIAL ottone / brass - alluminio / aluminium

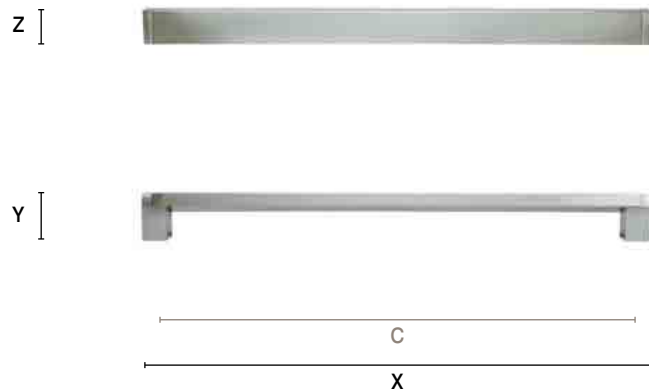

334

pag. 184

ARTICOLO ARTICLE	C INTERASSE CENTER DISTANCE	X LUNGHEZZA TOTALE TOTAL LENGTH	Z LARGHEZZA WIDTH	Y ALTEZZA HEIGHT
334	A RICHIESTA / ON REQUEST	-	25	35

MATERIALE PIEDINO - FOOT MATERIAL zama / zamak

MATERIALE TUBO - BAR MATERIAL ottone / brass - alluminio / aluminium

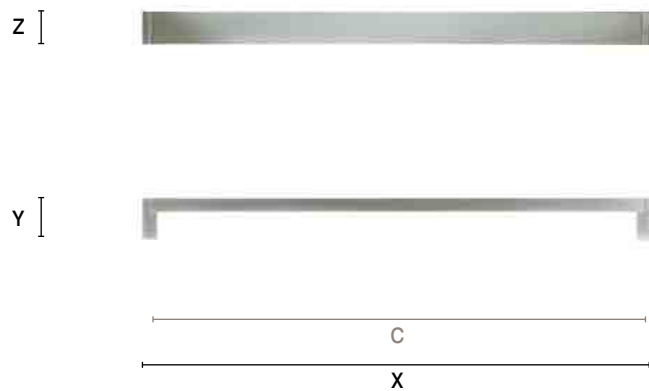

335

pag. 48

ARTICOLO ARTICLE	C INTERASSE CENTER DISTANCE	X LUNGHEZZA TOTALE TOTAL LENGTH	Z LARGHEZZA WIDTH	Y ALTEZZA HEIGHT
<b>335</b>	<b>96</b>	113	17	24

MATERIALE - MATERIAL zama / zamak

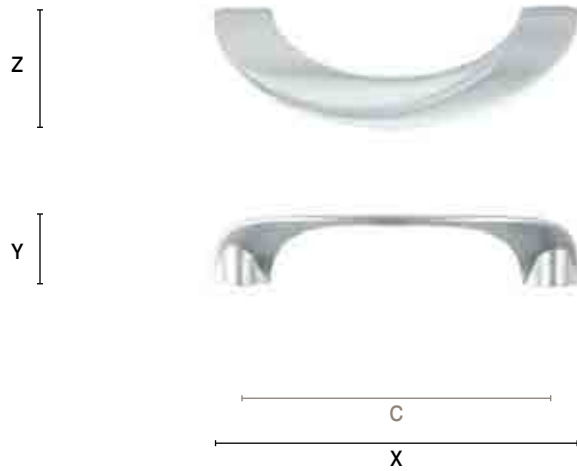

336

pag. 136

ARTICOLO ARTICLE	C INTERASSE CENTER DISTANCE	X LUNGHEZZA TOTALE TOTAL LENGTH	Z LARGHEZZA WIDTH	Y ALTEZZA HEIGHT
<b>336</b>	<b>32</b>	68	70	25

MATERIALE - MATERIAL zama / zamak

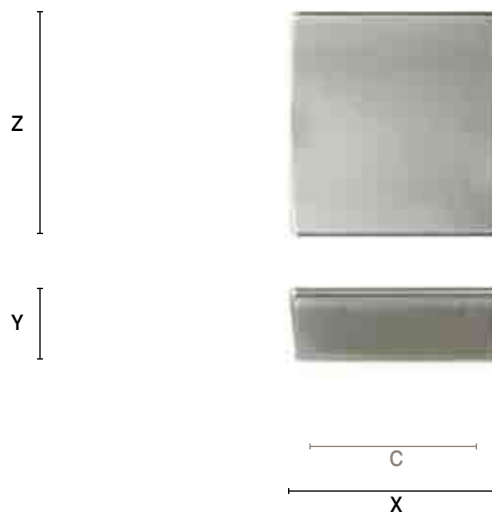

337

pag. 50

ARTICOLO ARTICLE	C INTERASSE CENTER DISTANCE	X LUNGHEZZA TOTALE TOTAL LENGTH	Z LARGHEZZA WIDTH	Y ALTEZZA HEIGHT
<b>337</b>	<b>160</b>	169	24	26

MATERIALE - MATERIAL zama / zamak

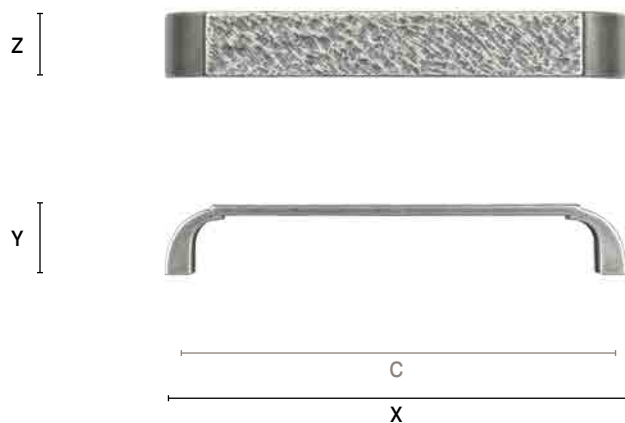

338

pag. 52

ARTICOLO ARTICLE	C INTERASSE CENTER DISTANCE	X LUNGHEZZA TOTALE TOTAL LENGTH	Z LARGHEZZA WIDTH	Y ALTEZZA HEIGHT
338 A	192	203	12	23
338 A	160	203	12	23
338 B	128	155	12	22

MATERIALE - MATERIAL zama / zamak

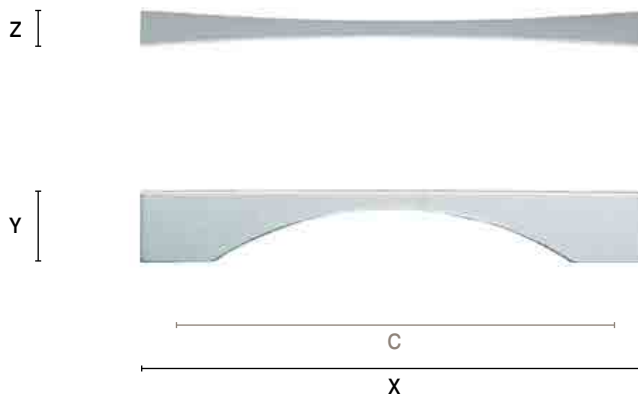

339

pag. 22

ARTICOLO ARTICLE	C INTERASSE CENTER DISTANCE	X LUNGHEZZA TOTALE TOTAL LENGTH	Z LARGHEZZA WIDTH	Y ALTEZZA HEIGHT
339	128	179	25	28

MATERIALE - MATERIAL zama / zamak

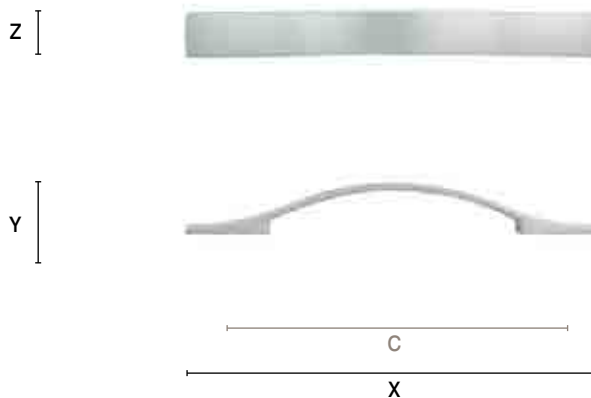

340

pag. 54

ARTICOLO ARTICLE	C INTERASSE CENTER DISTANCE	X LUNGHEZZA TOTALE TOTAL LENGTH	Z LARGHEZZA WIDTH	Y ALTEZZA HEIGHT
340	128	137	22	25
340	96	137	22	25

MATERIALE - MATERIAL zama / zamak

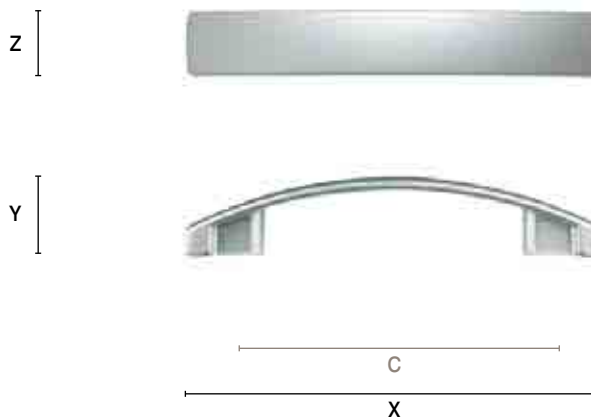

341

pag. 138

ARTICOLO ARTICLE	C INTERASSE CENTER DISTANCE	X LUNGHEZZA TOTALE TOTAL LENGTH	Z LARGHEZZA WIDTH	Y ALTEZZA HEIGHT
<b>341</b>	<b>96</b>	149	50	27

MATERIALE - MATERIAL zama / zamak

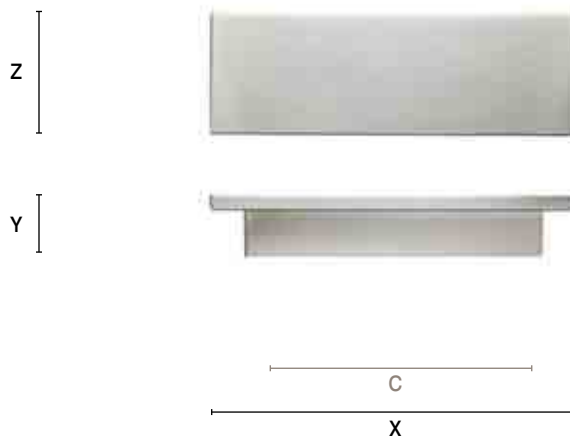

342

pag. 117

ARTICOLO ARTICLE	C INTERASSE CENTER DISTANCE	X LUNGHEZZA TOTALE TOTAL LENGTH	Z LARGHEZZA WIDTH	Y ALTEZZA HEIGHT
<b>342 A</b>	<b>160</b>	185	10	20
<b>342 A</b>	<b>96</b>	185	10	20
<b>342 B</b>	<b>128</b>	140	9	20
<b>342 B</b>	<b>96</b>	140	9	20
<b>342 C</b>	<b>32</b>	42	9	20

MATERIALE - MATERIAL zama / zamak

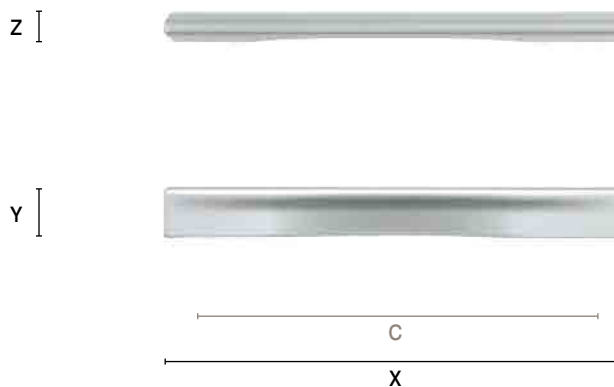

343

pag. 40

ARTICOLO ARTICLE	C INTERASSE CENTER DISTANCE	X LUNGHEZZA TOTALE TOTAL LENGTH	Z LARGHEZZA WIDTH	Y ALTEZZA HEIGHT
<b>343</b>	<b>320</b>	330	10	22
<b>343</b>	<b>288</b>	330	10	22

MATERIALE - MATERIAL zama / zamak

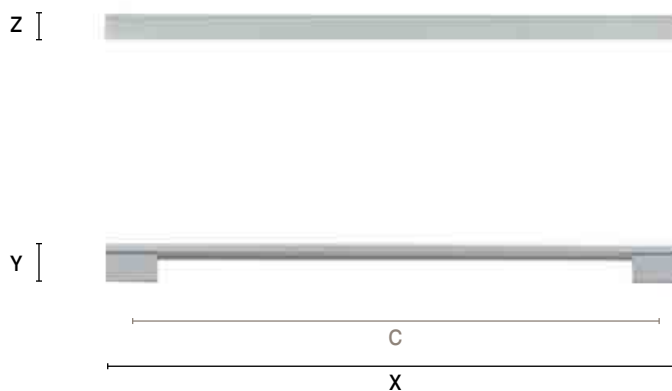



344

pag. 118

ARTICOLO ARTICLE	C INTERASSE CENTER DISTANCE	X LUNGHEZZA TOTALE TOTAL LENGTH	Z LARGHEZZA WIDTH	Y ALTEZZA HEIGHT
344	192	202	34	30
344	160	202	34	30

MATERIALE - MATERIAL zama / zamak

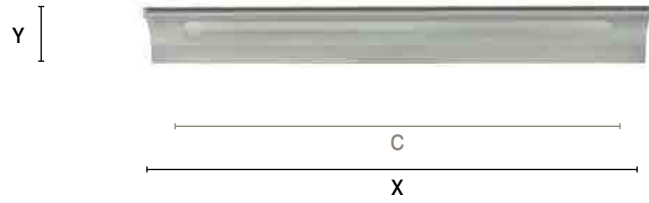
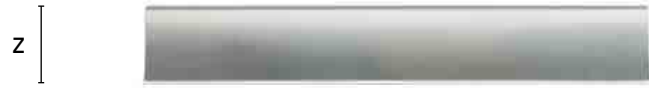

345

pag. 140

ARTICOLO ARTICLE	C INTERASSE CENTER DISTANCE	X LUNGHEZZA TOTALE TOTAL LENGTH	Z LARGHEZZA WIDTH	Y ALTEZZA HEIGHT
345	96	150	50	15

MATERIALE - MATERIAL zama / zamak

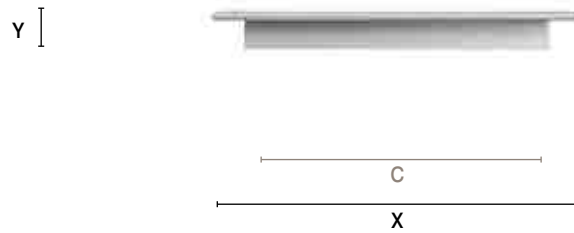
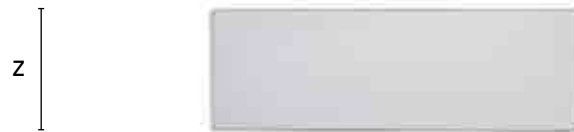

346

pag. 56

ARTICOLO ARTICLE	C INTERASSE CENTER DISTANCE	X LUNGHEZZA TOTALE TOTAL LENGTH	Z LARGHEZZA WIDTH	Y ALTEZZA HEIGHT
346	192	226	28	33

MATERIALE - MATERIAL zama / zamak

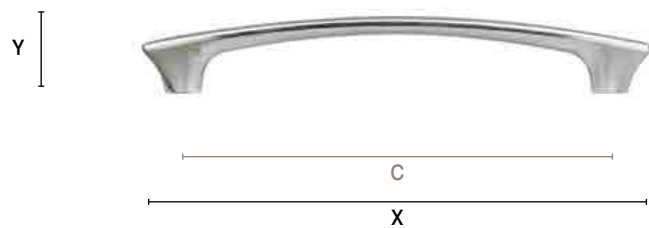

347

pag. 58

ARTICOLO ARTICLE	C INTERASSE CENTER DISTANCE	X LUNGHEZZA TOTALE TOTAL LENGTH	Z LARGHEZZA WIDTH	Y ALTEZZA HEIGHT
347 A	320	340	30	30
347 B	192	245	28	28
347 B	160	185	27	27

MATERIALE - MATERIAL zama / zamak

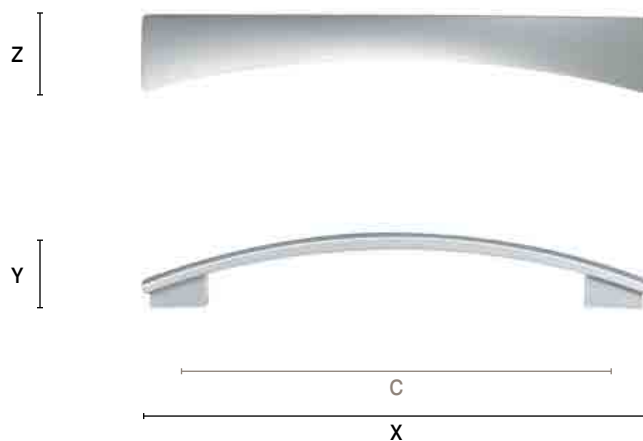

348

pag. 142

ARTICOLO ARTICLE	C INTERASSE CENTER DISTANCE	X LUNGHEZZA TOTALE TOTAL LENGTH	Z LARGHEZZA WIDTH	Y ALTEZZA HEIGHT
348 A	160	208	54	28
348 B	96	143	54	28

MATERIALE - MATERIAL zama / zamak

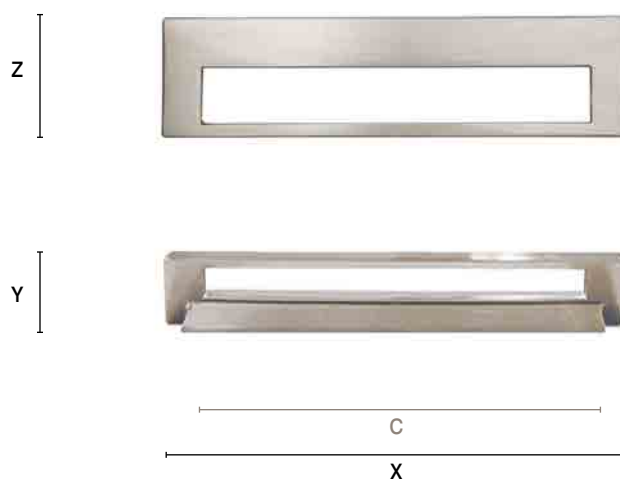

349

pag. 160

ARTICOLO ARTICLE	C INTERASSE CENTER DISTANCE	X LUNGHEZZA TOTALE TOTAL LENGTH	Z LARGHEZZA WIDTH	Y ALTEZZA HEIGHT
349 A	120	150	35	11
349 B	96	130	33	11
349 SP	96	130	38	11

MATERIALE - MATERIAL zama / zamak

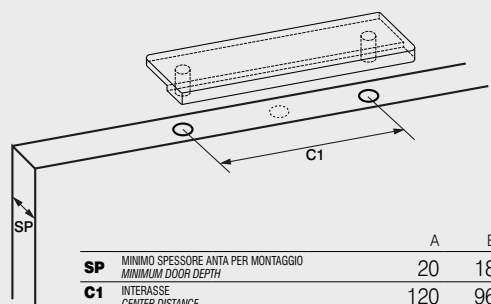

	A	B	SP
SP	20	18	18
C1	120	96	96

+ FORO CENTRALE / CENTRAL HOLE

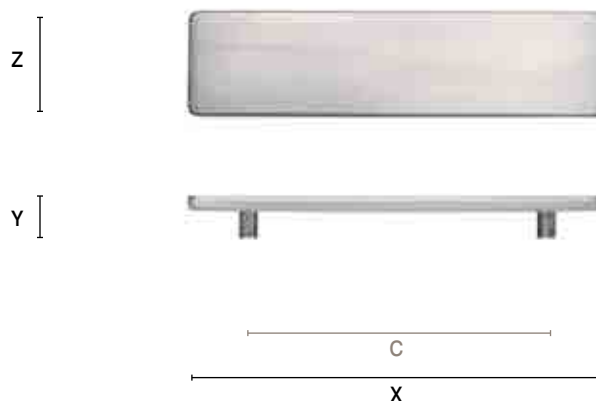

350

pag. 60

ARTICOLO ARTICLE	C INTERASSE CENTER DISTANCE	X LUNGHEZZA TOTALE TOTAL LENGTH	Z LARGHEZZA WIDTH	Y ALTEZZA HEIGHT
350 A	320	335	14	30
350	256	265	14	30
350	224	265	14	30
350 B	160	180	13	30

MATERIALE - MATERIAL zama / zamak

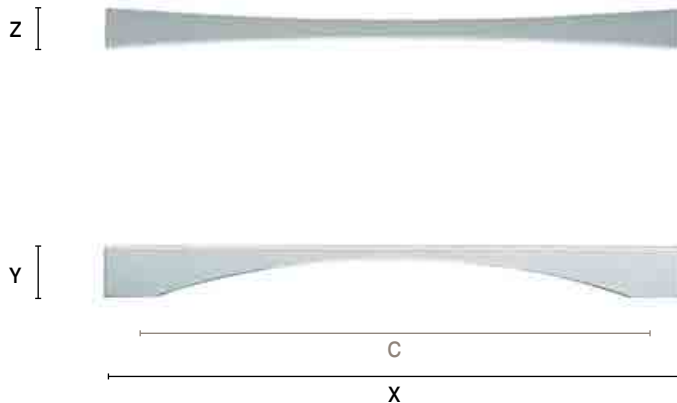

351

pag. 120

ARTICOLO ARTICLE	C INTERASSE CENTER DISTANCE	X LUNGHEZZA TOTALE TOTAL LENGTH	Z LARGHEZZA WIDTH	Y ALTEZZA HEIGHT
351 A	160	173	9	15
351 B	96	110	9	15

MATERIALE - MATERIAL zama / zamak

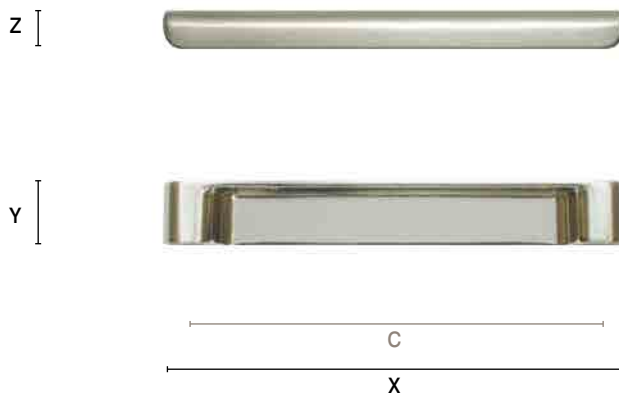

352

pag. 144

ARTICOLO ARTICLE	C INTERASSE CENTER DISTANCE	X LUNGHEZZA TOTALE TOTAL LENGTH	Z LARGHEZZA WIDTH	Y ALTEZZA HEIGHT
352 A	32	80	80	27
352 B	32	60	60	25

MATERIALE - MATERIAL zama / zamak

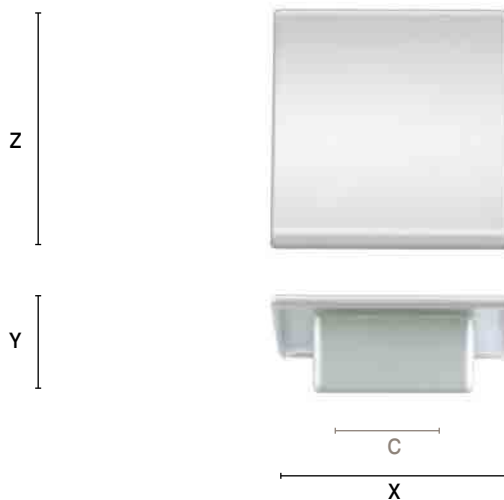

352 pelle / leather

pag. 144

ARTICOLO ARTICLE	C INTERASSE CENTER DISTANCE	X LUNGHEZZA TOTALE TOTAL LENGTH	Z LARGHEZZA WIDTH	Y ALTEZZA HEIGHT
352 A	32	80	80	27
352 B	32	60	60	25

MATERIALE - MATERIAL zama / zamak - pelle naturale / leather

353

pag. 146

ARTICOLO ARTICLE	C INTERASSE CENTER DISTANCE	X LUNGHEZZA TOTALE TOTAL LENGTH	Z LARGHEZZA WIDTH	Y ALTEZZA HEIGHT
<b>353</b>	<b>32</b>	60	60	23

MATERIALE - MATERIAL zama / zamak

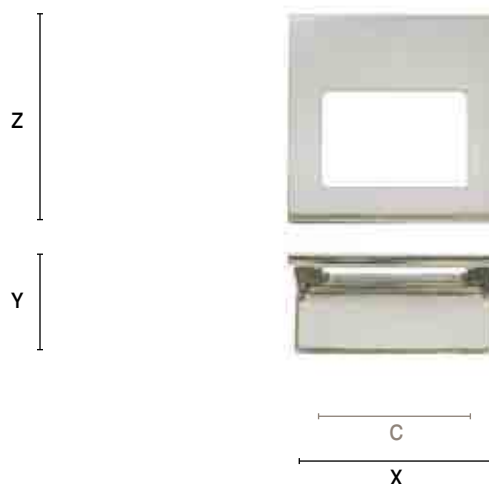

354

pag. 186

ARTICOLO ARTICLE	C INTERASSE CENTER DISTANCE	X LUNGHEZZA TOTALE TOTAL LENGTH	Z LARGHEZZA WIDTH	Y ALTEZZA HEIGHT
<b>354</b>	A RICHIESTA / ON REQUEST	-	20	40

MATERIALE PIEDINO - FOOT MATERIAL zama / zamak  
MATERIALE TUBO - BAR MATERIAL ferro / iron

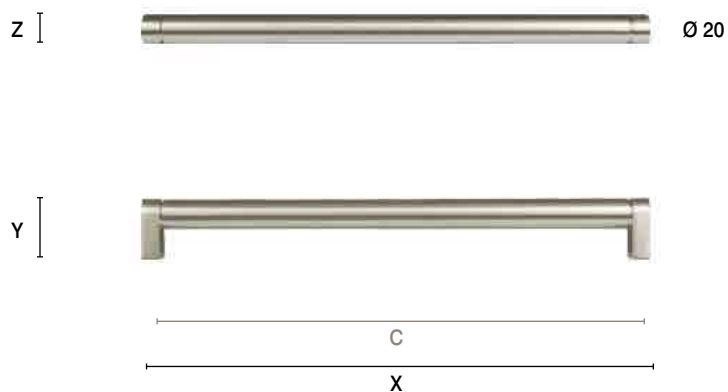

355

pag. 62

ARTICOLO ARTICLE	C INTERASSE CENTER DISTANCE	X LUNGHEZZA TOTALE TOTAL LENGTH	Z LARGHEZZA WIDTH	Y ALTEZZA HEIGHT
<b>355</b>	<b>160</b>	165	8	26
<b>355</b>	<b>128</b>	165	8	26

MATERIALE - MATERIAL zama / zamak

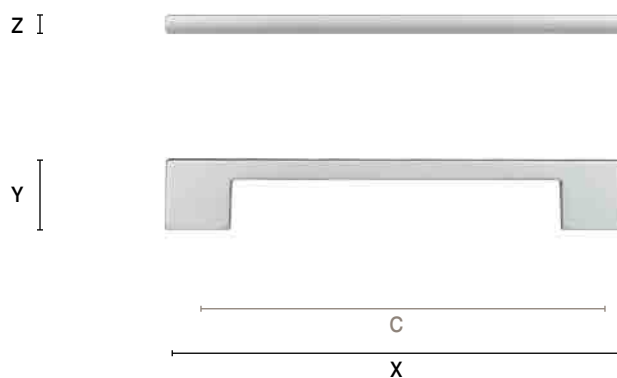

356

pag. 147

ARTICOLO ARTICLE	C INTERASSE CENTER DISTANCE	X LUNGHEZZA TOTALE TOTAL LENGTH	Z LARGHEZZA WIDTH	Y ALTEZZA HEIGHT
<b>356</b>	<b>160</b>	170	60	25

MATERIALE - MATERIAL zama / zamak



357

pag. 64

ARTICOLO ARTICLE	C INTERASSE CENTER DISTANCE	X LUNGHEZZA TOTALE TOTAL LENGTH	Z LARGHEZZA WIDTH	Y ALTEZZA HEIGHT
<b>357 A</b>	<b>320</b>	359	10	31
<b>357 A</b>	<b>256</b>	359	10	31
<b>357 B</b>	<b>192</b>	243	10	29
<b>357 B</b>	<b>160</b>	243	10	29
<b>357 C</b>	<b>128</b>	143	10	27
<b>357 C</b>	<b>96</b>	143	10	27

MATERIALE - MATERIAL zama - alluminio / zamak - aluminium

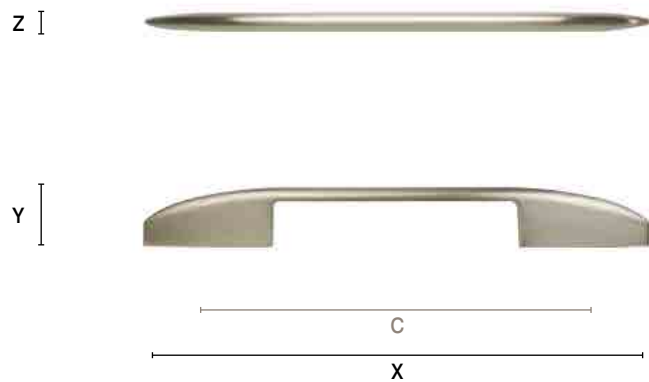

358

pag. 188

ARTICOLO ARTICLE	C INTERASSE CENTER DISTANCE	X LUNGHEZZA TOTALE TOTAL LENGTH	Z LARGHEZZA WIDTH	Y ALTEZZA HEIGHT
<b>358</b>	A RICHIESTA / ON REQUEST	-	28	25

MATERIALE PIEDINO - FOOT MATERIAL zama / zamak

MATERIALE TUBO - BAR MATERIAL ottone / brass - alluminio / aluminium

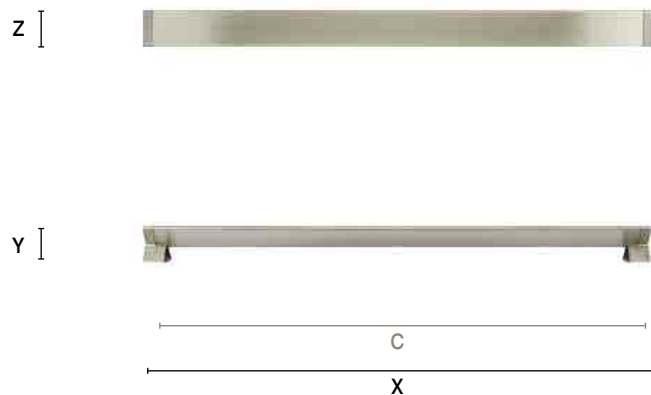

359

pag. 122

ARTICOLO ARTICLE	C INTERASSE CENTER DISTANCE	X LUNGHEZZA TOTALE TOTAL LENGTH	Z LARGHEZZA WIDTH	Y ALTEZZA HEIGHT
359 A	192	230	30	26
359 A	160	230	30	26

MATERIALE - MATERIAL zama / zamak

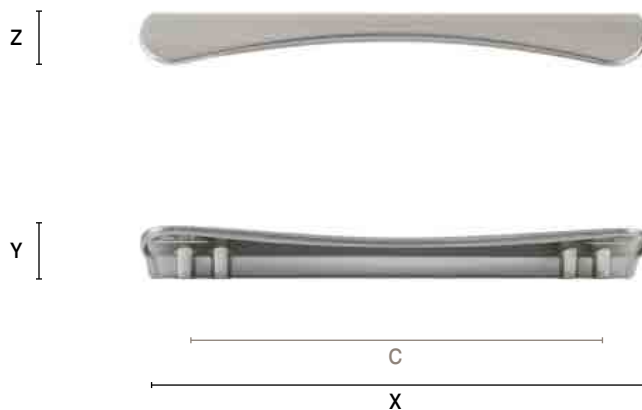

360

pag. 66

ARTICOLO ARTICLE	C INTERASSE CENTER DISTANCE	X LUNGHEZZA TOTALE TOTAL LENGTH	Z LARGHEZZA WIDTH	Y ALTEZZA HEIGHT
360 A	320	352	32	25
360 B	160	194	28	25
360 C	96	123	28	25

MATERIALE - MATERIAL zama / zamak

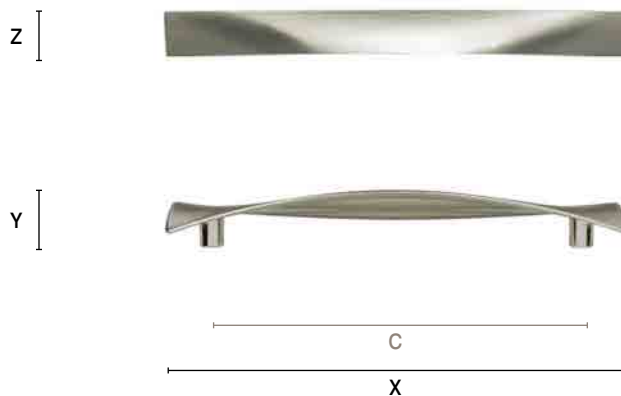

361

pag. 148

ARTICOLO ARTICLE	C INTERASSE CENTER DISTANCE	X LUNGHEZZA TOTALE TOTAL LENGTH	Z LARGHEZZA WIDTH	Y ALTEZZA HEIGHT
361 A	64	80	80	22

MATERIALE - MATERIAL zama / zamak

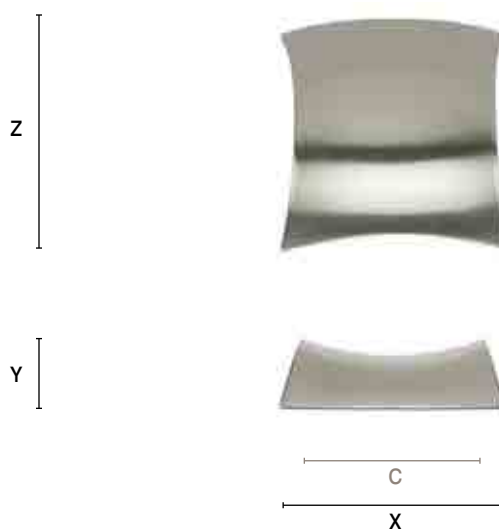

362

pag. 68

ARTICOLO ARTICLE	C INTERASSE CENTER DISTANCE	X LUNGHEZZA TOTALE TOTAL LENGTH	Z LARGHEZZA WIDTH	Y ALTEZZA HEIGHT
362 B	224	234	9	32

MATERIALE - MATERIAL zama / zamak

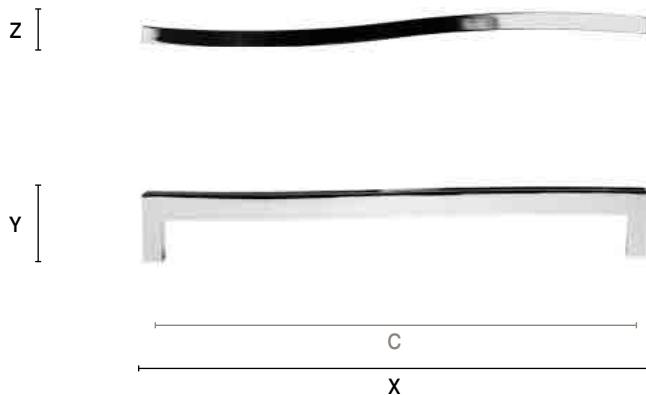

363

pag. 162

ARTICOLO ARTICLE	C INTERASSE CENTER DISTANCE	X LUNGHEZZA TOTALE TOTAL LENGTH	Z LARGHEZZA WIDTH	Y ALTEZZA HEIGHT
363 B	160	170	20	14
363 c	64	70	20	14

MATERIALE - MATERIAL zama / zamak

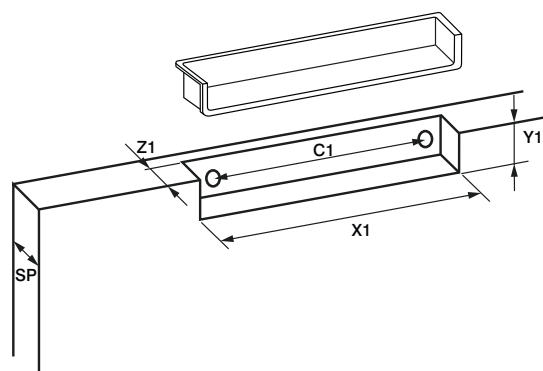
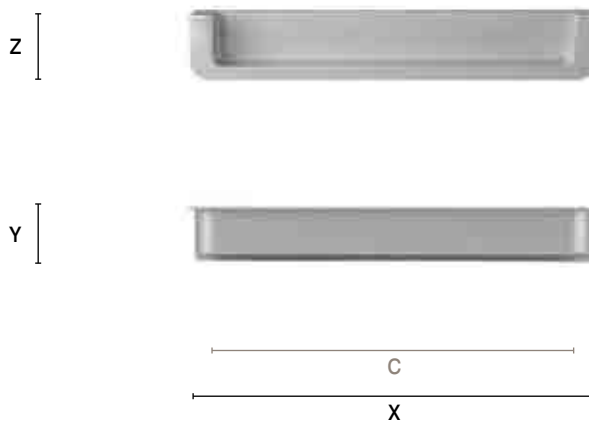

	B	C
SP	MINIMO SPESSORE ANTA PER MONTAGGIO MINIMUM DOOR DEPTH	18 18
C1	INTERASSE CENTER DISTANCE	160 64
X1	LUNGHEZZA FRESATA TOTAL LENGTH OF THE DOOR GROOVE	166 68
Z1	LARGHEZZA FRESATA TOTAL WIDTH OF THE DOOR GROOVE	17 17
Y1	ALTEZZA FRESATA TOTAL HEIGHT OF THE DOOR GROOVE	13 13

364

pag. 70

ARTICOLO ARTICLE	C INTERASSE CENTER DISTANCE	X LUNGHEZZA TOTALE TOTAL LENGTH	Z LARGHEZZA WIDTH	Y ALTEZZA HEIGHT
364	480	495	35	30
364	320	335	35	30
364	160	175	35	30

MATERIALE - MATERIAL zama-vetro / zamak-glass

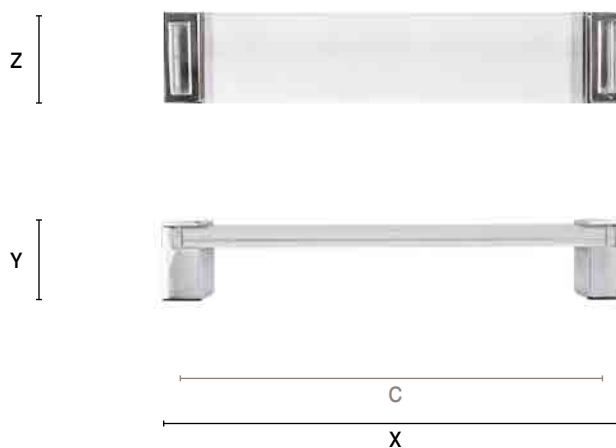

365

pag. 124

ARTICOLO ARTICLE	C INTERASSE CENTER DISTANCE	X LUNGHEZZA TOTALE TOTAL LENGTH	Z LARGHEZZA WIDTH	Y ALTEZZA HEIGHT
365 B	128	146	27	23
365 B	96	146	27	23

MATERIALE - MATERIAL zama / zamak



366

pag. 126

ARTICOLO ARTICLE	C INTERASSE CENTER DISTANCE	X LUNGHEZZA TOTALE TOTAL LENGTH	Z LARGHEZZA WIDTH	Y ALTEZZA HEIGHT
366 B	192	210	13	10
366 B	160	210	13	10
366 C	96	114	13	10
366 C	64	114	13	10

MATERIALE - MATERIAL zama / zamak

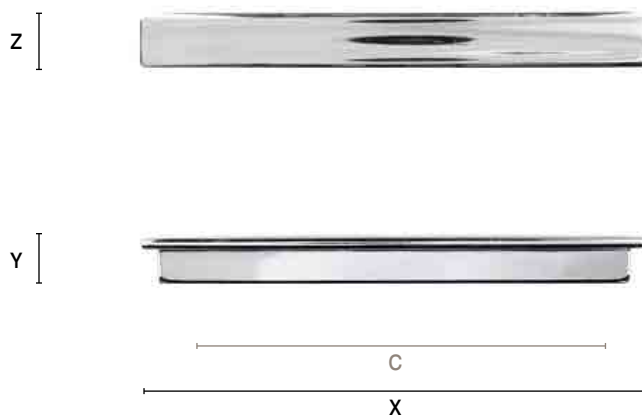



367

pag. 74

ARTICOLO ARTICLE	C INTERASSE CENTER DISTANCE	X LUNGHEZZA TOTALE TOTAL LENGTH	Z LARGHEZZA WIDTH	Y ALTEZZA HEIGHT
367	96	110	42	27

MATERIALE - MATERIAL zama / zamak

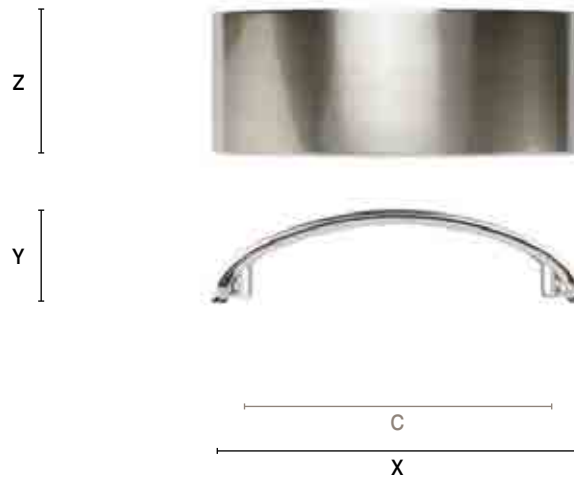

368

pag. 76

ARTICOLO ARTICLE	C INTERASSE CENTER DISTANCE	X LUNGHEZZA TOTALE TOTAL LENGTH	Z LARGHEZZA WIDTH	Y ALTEZZA HEIGHT
368 A	320	330	9	33
368 A	288	330	9	33
368 B	224	240	9	32
368 B	192	240	9	32
368 C	160	177	9	32
368 C	128	177	9	32
368 D	96	110	9	28
368 D	64	110	9	28

MATERIALE - MATERIAL zama / zamak

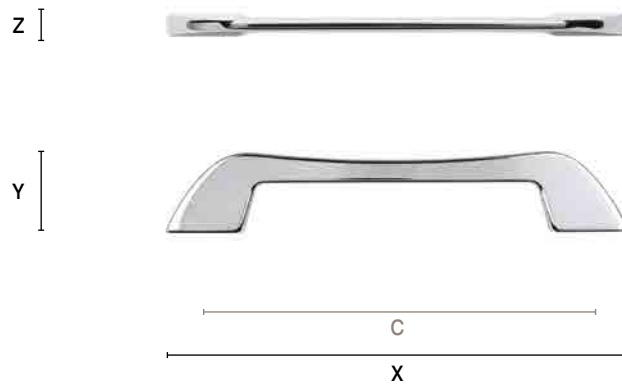

369

pag. 78

ARTICOLO ARTICLE	C INTERASSE CENTER DISTANCE	X LUNGHEZZA TOTALE TOTAL LENGTH	Z LARGHEZZA WIDTH	Y ALTEZZA HEIGHT
369 B	160	210	30	23
369 C	128	163	30	23

MATERIALE - MATERIAL zama / zamak

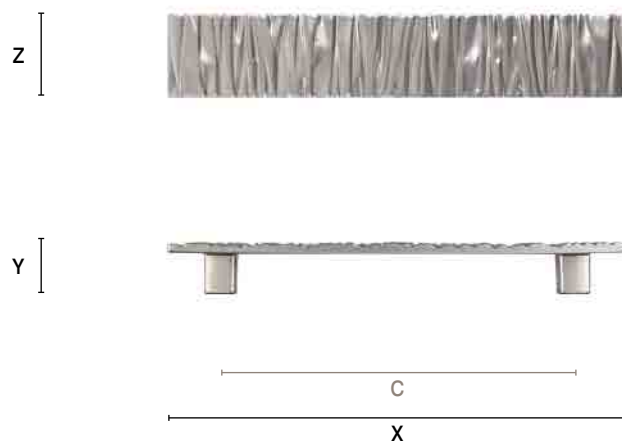

370

pag. 72

ARTICOLO ARTICLE	C INTERASSE CENTER DISTANCE	X LUNGHEZZA TOTALE TOTAL LENGTH	Z LARGHEZZA WIDTH	Y ALTEZZA HEIGHT
370	480	495	35	30
370	320	335	35	30
370	160	175	35	30

MATERIALE - MATERIAL zama-vetro / zamak-glass



371

pag. 190

ARTICOLO ARTICLE	C INTERASSE CENTER DISTANCE	X LUNGHEZZA TOTALE TOTAL LENGTH	Z LARGHEZZA WIDTH	Y ALTEZZA HEIGHT
371	A RICHIESTA / ON REQUEST	-	10	32

MATERIALE PIEDINO - FOOT MATERIAL zama / zamak  
MATERIALE TUBO - BAR MATERIAL ferro / iron

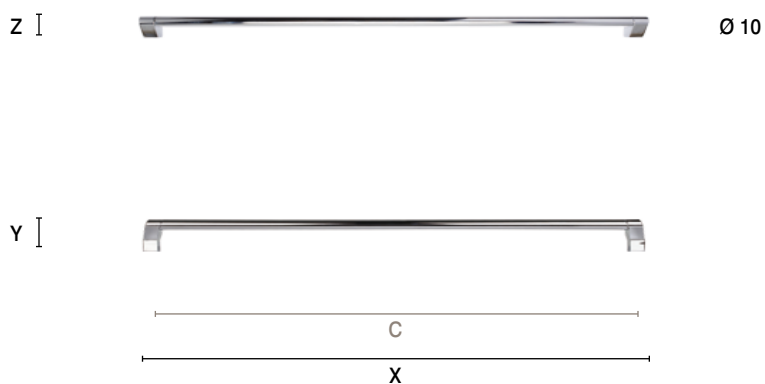

372

pag. 191

ARTICOLO ARTICLE	C INTERASSE CENTER DISTANCE	X LUNGHEZZA TOTALE TOTAL LENGTH	Z LARGHEZZA WIDTH	Y ALTEZZA HEIGHT
372	A RICHIESTA / ON REQUEST	-	10	30

MATERIALE PIEDINO - FOOT MATERIAL zama / zamak  
MATERIALE TUBO - BAR MATERIAL ferro / iron

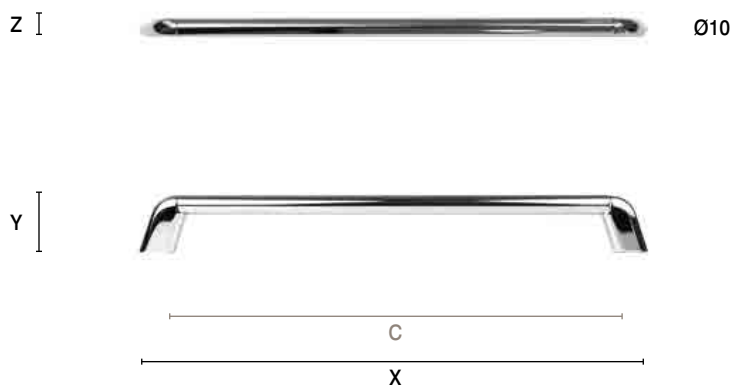

ARTICOLO ARTICLE	<b>C</b> INTERASSE CENTER DISTANCE	<b>X</b> LUNGHEZZA TOTALE TOTAL LENGTH	<b>Z</b> LARGHEZZA WIDTH	<b>Y</b> ALTEZZA HEIGHT
<b>373</b>	A RICHIESTA / ON REQUEST	-	10	30

MATERIALE PIEDINO - FOOT MATERIAL zama / zamak  
MATERIALE TUBO - BAR MATERIAL ferro / iron

Z I  Ø 10

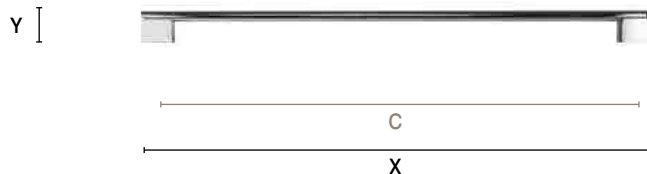

ARTICOLO ARTICLE	<b>C</b> INTERASSE CENTER DISTANCE	<b>X</b> LUNGHEZZA TOTALE TOTAL LENGTH	<b>Z</b> LARGHEZZA WIDTH	<b>Y</b> ALTEZZA HEIGHT
<b>374 B</b>	<b>160</b>	180	54	16
<b>374 B</b>	<b>128</b>	180	54	16
<b>374 c</b>	<b>32</b>	54	54	16

MATERIALE - MATERIAL zama / zamak

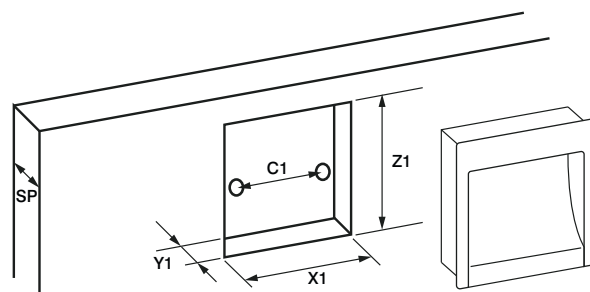
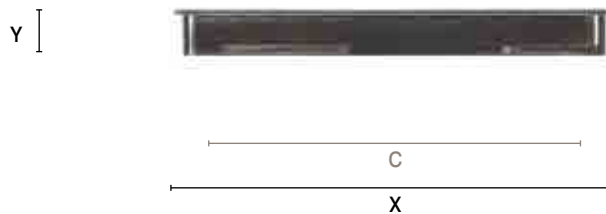

	B	C
<b>SP</b> MINIMO SPESSORE ANTA PER MONTAGGIO MINIMUM DOOR DEPTH	18	18
<b>C1</b> INTERASSE CENTER DISTANCE	128/160	32
<b>X1</b> LUNGHEZZA FRESATA TOTAL LENGTH OF THE DOOR GROOVE	179	51
<b>Z1</b> LARGHEZZA FRESATA TOTAL WIDTH OF THE DOOR GROOVE	51	51
<b>Y1</b> ALTEZZA FRESATA TOTAL HEIGHT OF THE DOOR GROOVE	16	16

375

pag. 150

ARTICOLO ARTICLE	C INTERASSE CENTER DISTANCE	X LUNGHEZZA TOTALE TOTAL LENGTH	Z LARGHEZZA WIDTH	Y ALTEZZA HEIGHT
375 A	32	94	59	43
375 B	16	64	44	43

MATERIALE - MATERIAL zama / zamak

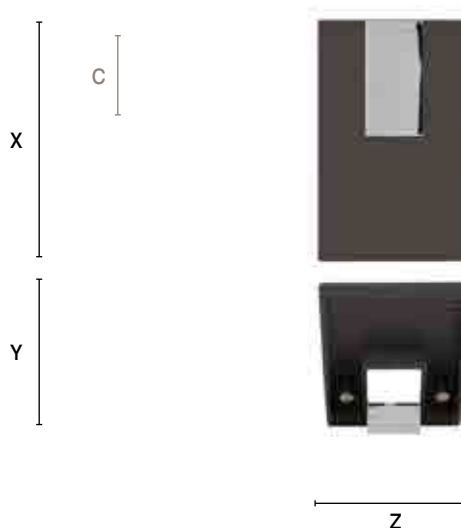

376

pag. 151

ARTICOLO ARTICLE	C INTERASSE CENTER DISTANCE	X LUNGHEZZA TOTALE TOTAL LENGTH	Z LARGHEZZA WIDTH	Y ALTEZZA HEIGHT
376 A - K	32	94	59	43
376 B - K	16	64	44	43

MATERIALE - MATERIAL zama / zamak

K = CON CRISTALLI SWAROVSKI / WITH SWAROVSKI CRYSTALS

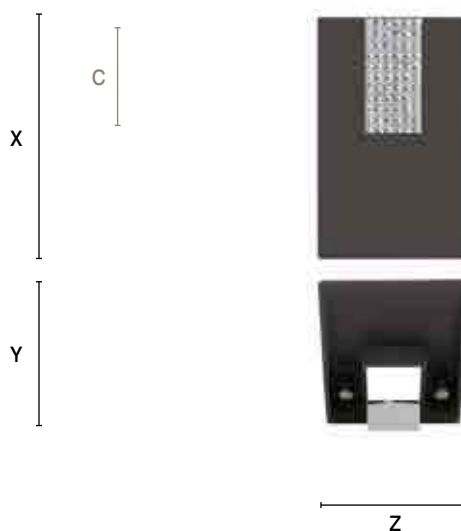

377

pag. 80

ARTICOLO ARTICLE	C INTERASSE CENTER DISTANCE	X LUNGHEZZA TOTALE TOTAL LENGTH	Z LARGHEZZA WIDTH	Y ALTEZZA HEIGHT
377 B	320	342	75	25
377 C	160	182	75	25

MATERIALE - MATERIAL zama / zamak

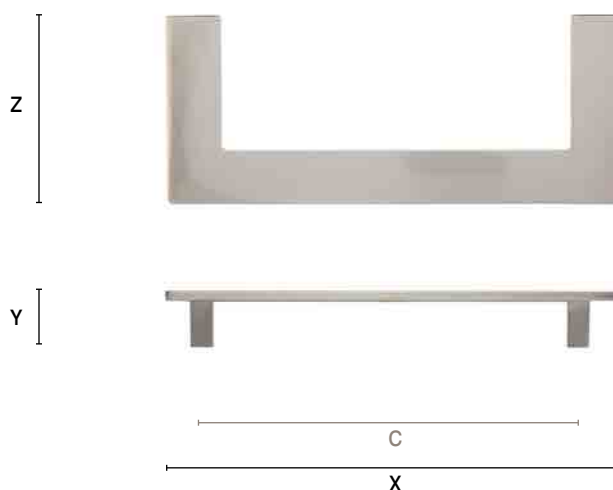

378

pag. 152

ARTICOLO ARTICLE	C INTERASSE CENTER DISTANCE	X LUNGHEZZA TOTALE TOTAL LENGTH	Z LARGHEZZA WIDTH	Y ALTEZZA HEIGHT
378 B	128	140	42	19
378 c	32	42	42	19

MATERIALE - MATERIAL zama / zamak



379

pag. 82

ARTICOLO ARTICLE	C INTERASSE CENTER DISTANCE	X LUNGHEZZA TOTALE TOTAL LENGTH	Z LARGHEZZA WIDTH	Y ALTEZZA HEIGHT
379	64	89	72	27

MATERIALE - MATERIAL zama / zamak

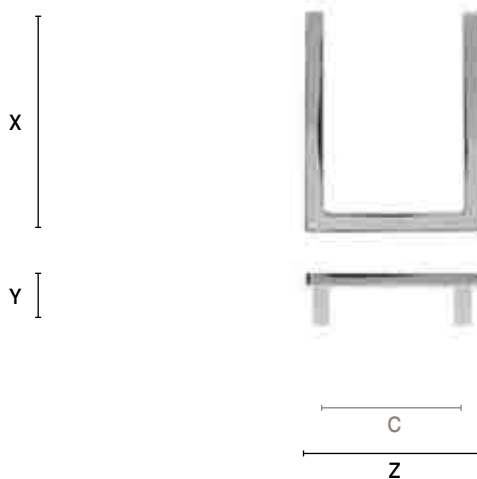

380

pag. 130

ARTICOLO ARTICLE	C INTERASSE CENTER DISTANCE	X LUNGHEZZA TOTALE TOTAL LENGTH	Z LARGHEZZA WIDTH	Y ALTEZZA HEIGHT
380	96	126,5	126,5	22

MATERIALE - MATERIAL zama / zamak

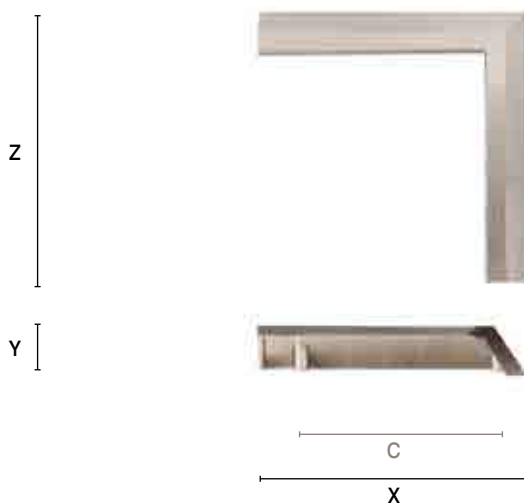

381

pag. 128

ARTICOLO ARTICLE	C INTERASSE CENTER DISTANCE	X LUNGHEZZA TOTALE TOTAL LENGTH	Z LARGHEZZA WIDTH	Y ALTEZZA HEIGHT
381 A	320	352	24	22
381 B	192	224	24	22
381 C	96	128	24	22

MATERIALE - MATERIAL zama / zamak

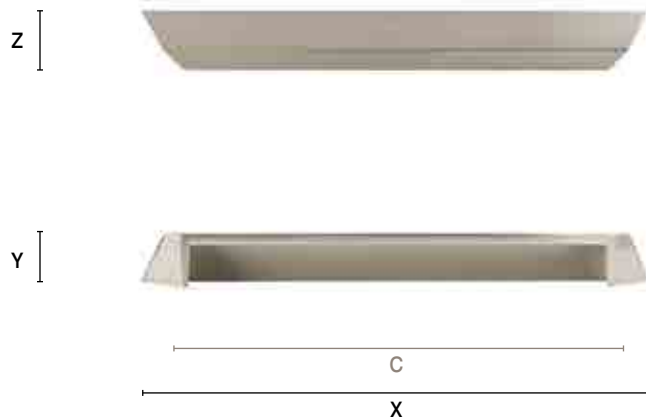

382

pag. 84

ARTICOLO ARTICLE	C INTERASSE CENTER DISTANCE	X LUNGHEZZA TOTALE TOTAL LENGTH	Z LARGHEZZA WIDTH	Y ALTEZZA HEIGHT
382 A	320	345	20	21
382 C	160	185	20	20

MATERIALE - MATERIAL zama / zamak

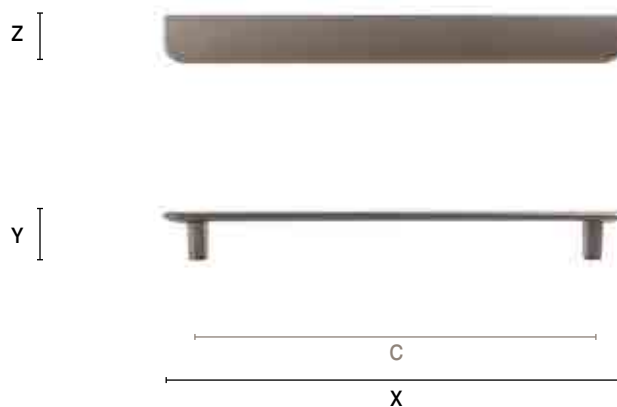

383

pag. 86

ARTICOLO ARTICLE	C INTERASSE CENTER DISTANCE	X LUNGHEZZA TOTALE TOTAL LENGTH	Z LARGHEZZA WIDTH	Y ALTEZZA HEIGHT
383 A	320	372	24	30
383 C	160	214	24	30

MATERIALE - MATERIAL zama / zamak

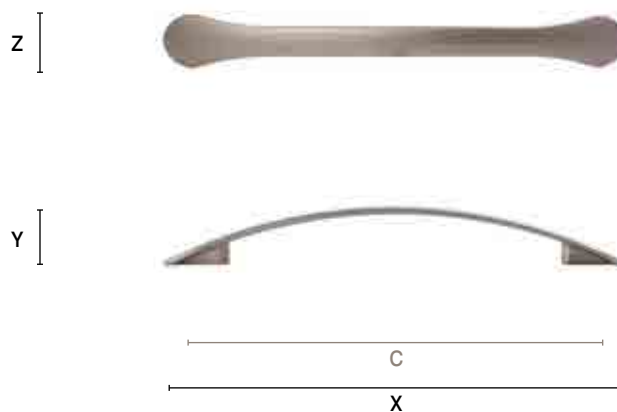

384

pag. 88

ARTICOLO ARTICLE	C INTERASSE CENTER DISTANCE	X LUNGHEZZA TOTALE TOTAL LENGTH	Z LARGHEZZA WIDTH	Y ALTEZZA HEIGHT
384 A	96	140	38	30
384 B	64	92	24	25

MATERIALE - MATERIAL zama / zamak

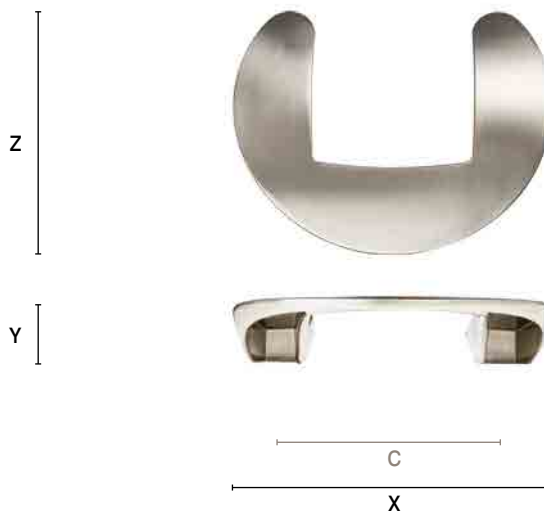

385

pag. 89

ARTICOLO ARTICLE	C INTERASSE CENTER DISTANCE	X LUNGHEZZA TOTALE TOTAL LENGTH	Z LARGHEZZA WIDTH	Y ALTEZZA HEIGHT
385 B	128	158	24	23
385 c	96	117	24	23

MATERIALE - MATERIAL zama / zamak

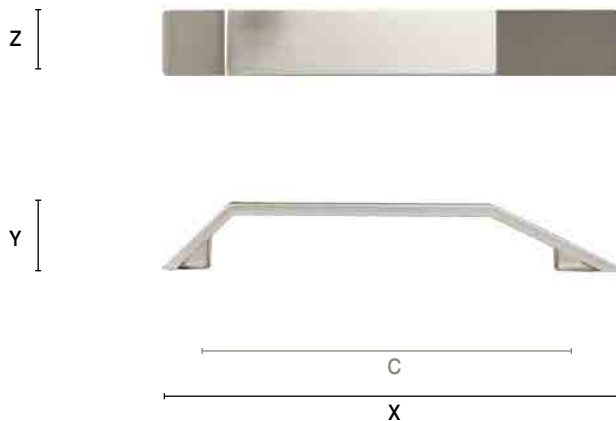

386

pag. 90

ARTICOLO ARTICLE	C INTERASSE CENTER DISTANCE	X LUNGHEZZA TOTALE TOTAL LENGTH	Z LARGHEZZA WIDTH	Y ALTEZZA HEIGHT
386 A	320	380	12	30
386 c	160	222	12	29
386 D	96	149	12	29

MATERIALE - MATERIAL zama / zamak

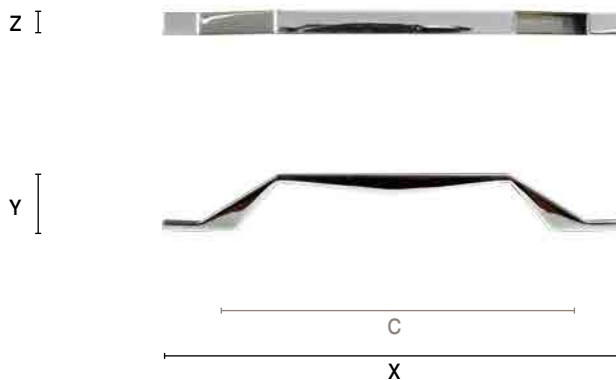

387

pag. 92

ARTICOLO ARTICLE	C INTERASSE CENTER DISTANCE	X LUNGHEZZA TOTALE TOTAL LENGTH	Z LARGHEZZA WIDTH	Y ALTEZZA HEIGHT
387 A	256	285	18	29
387 A	224	285	18	29
387 B	160	215	18	29
387 C	96	124	17	28

MATERIALE - MATERIAL zama / zamak

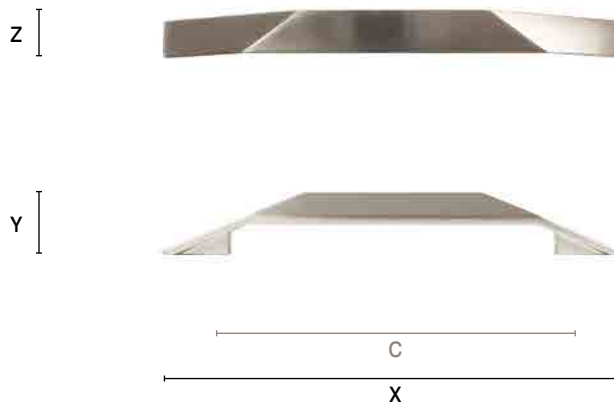

388

pag. 166

ARTICOLO ARTICLE	C INTERASSE CENTER DISTANCE	X LUNGHEZZA TOTALE TOTAL LENGTH	Z LARGHEZZA WIDTH	Y ALTEZZA HEIGHT
388 B	128	175	20	20
388 C	64	110	20	20

MATERIALE - MATERIAL zama / zamak

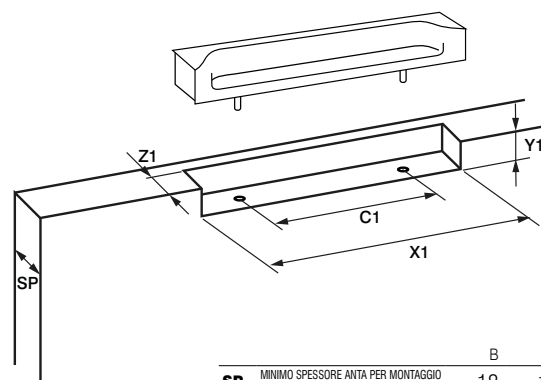
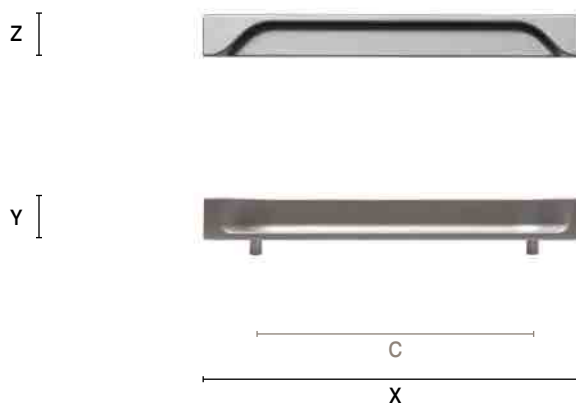

	B	C
SP	18	18
C1	128	64
X1	165	104
Z1	17	17
Y1	16	16



389

pag. 154

ARTICOLO ARTICLE	C INTERASSE CENTER DISTANCE	X LUNGHEZZA TOTALE TOTAL LENGTH	Z LARGHEZZA WIDTH	Y ALTEZZA HEIGHT
389 B	128	162	55	24
389 c	16	40	55	24

MATERIALE - MATERIAL zama / zamak



390

pag. 131

ARTICOLO ARTICLE	C INTERASSE CENTER DISTANCE	X LUNGHEZZA TOTALE TOTAL LENGTH	Z LARGHEZZA WIDTH	Y ALTEZZA HEIGHT
390 B	160	204	41	26
390 c	96	132	41	26

MATERIALE - MATERIAL zama / zamak

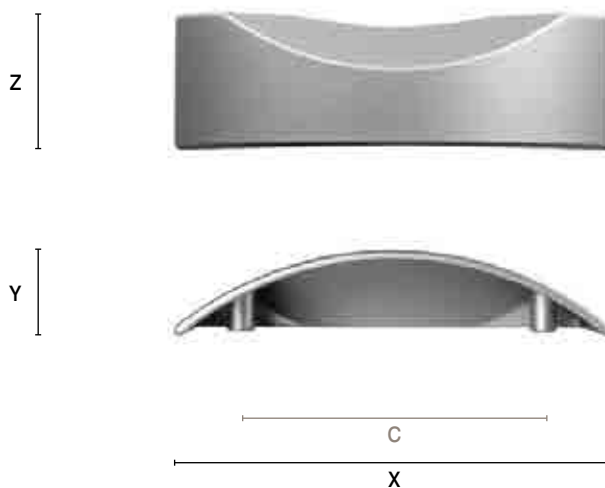

391

pag. 167

ARTICOLO ARTICLE	C INTERASSE CENTER DISTANCE	X LUNGHEZZA TOTALE TOTAL LENGTH	Z LARGHEZZA WIDTH	Y ALTEZZA HEIGHT
391	64	150	50	14

MATERIALE - MATERIAL zama / zamak

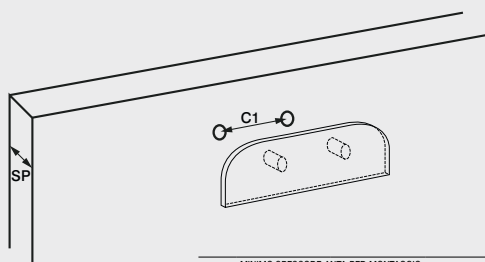

SP	MINIMO SPESSORE ANTA PER MONTAGGIO MINIMUM DOOR DEPTH	12
C1	INTERASSE CENTER DISTANCE	64

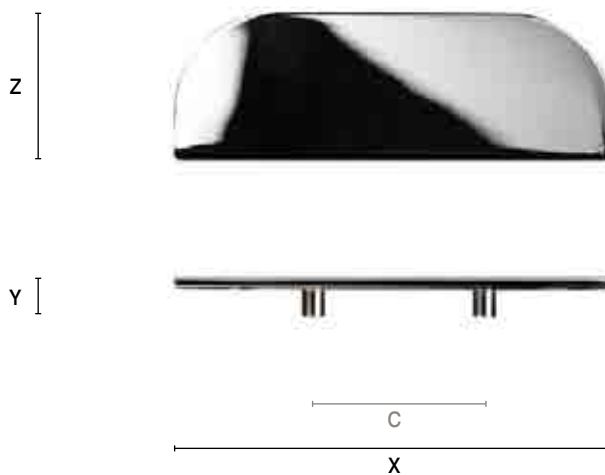

392

pag. 94

ARTICOLO ARTICLE	C INTERASSE CENTER DISTANCE	X LUNGHEZZA TOTALE TOTAL LENGTH	Z LARGHEZZA WIDTH	Y ALTEZZA HEIGHT
392 A	320	330	16	24
392 A	288	330	16	24
392 B	192	202	14	24
392 B	160	202	14	24
392 A-K	320	330	16	24
392 A-K	288	330	16	24
392 B-K	192	202	14	24
392 B-K	160	202	14	24

MATERIALE - MATERIAL zama / zamak

K = CON CRISTALLI / WITH CRYSTALS

Z I



Y I

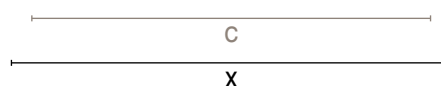

393

pag. 95

ARTICOLO ARTICLE	C INTERASSE CENTER DISTANCE	X LUNGHEZZA TOTALE TOTAL LENGTH	Z LARGHEZZA WIDTH	Y ALTEZZA HEIGHT
393 c	128	155	36	24

MATERIALE - MATERIAL zama / zamak

Z I



Y I

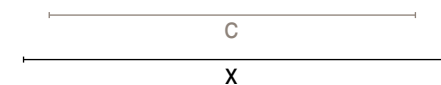

394

pag. 96

ARTICOLO ARTICLE	C INTERASSE CENTER DISTANCE	X LUNGHEZZA TOTALE TOTAL LENGTH	Z LARGHEZZA WIDTH	Y ALTEZZA HEIGHT
394 A	320	374	21	27
394 B	160	200	21	27

MATERIALE - MATERIAL zama / zamak

Z I



Y I

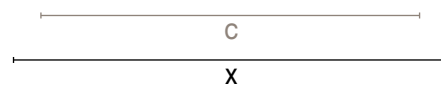

395

pag. 168

ARTICOLO ARTICLE	C INTERASSE CENTER DISTANCE	X LUNGHEZZA TOTALE TOTAL LENGTH	Z LARGHEZZA WIDTH	Y ALTEZZA HEIGHT
395 D/S	32	70	60	20

MATERIALE - MATERIAL zama / zamak

D/S = RIGHT / LEFT

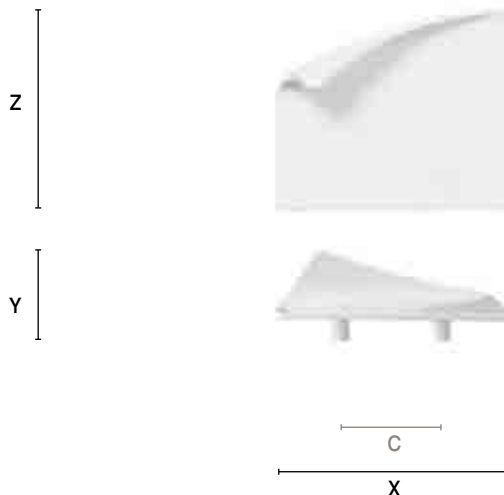
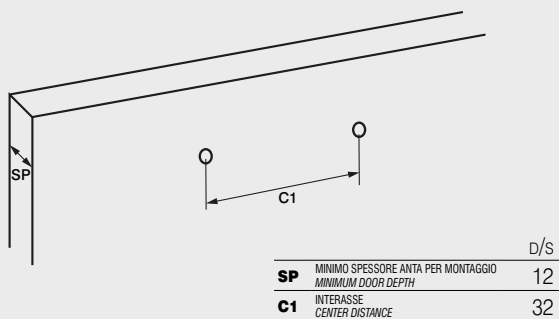

396

pag. 169

ARTICOLO ARTICLE	C INTERASSE CENTER DISTANCE	X LUNGHEZZA TOTALE TOTAL LENGTH	Z LARGHEZZA WIDTH	Y ALTEZZA HEIGHT
396 D/S	128	148	23	18

MATERIALE - MATERIAL zama / zamak

D/S = RIGHT / LEFT

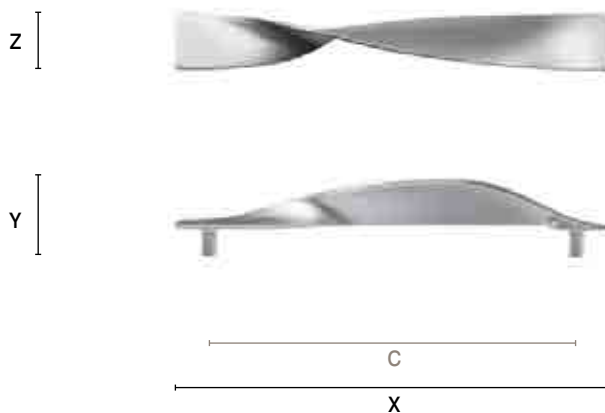
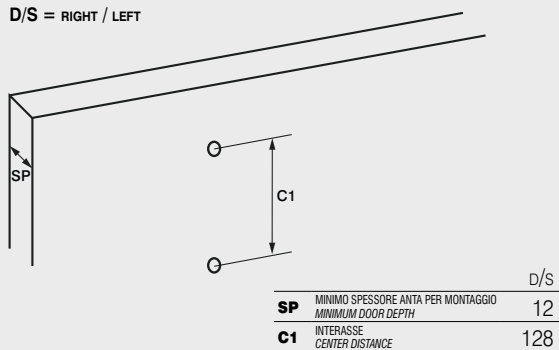

397

pag. 97

ARTICOLO ARTICLE	C INTERASSE CENTER DISTANCE	X LUNGHEZZA TOTALE TOTAL LENGTH	Z LARGHEZZA WIDTH	Y ALTEZZA HEIGHT
397 B	160	230	18	26

MATERIALE - MATERIAL zama / zamak

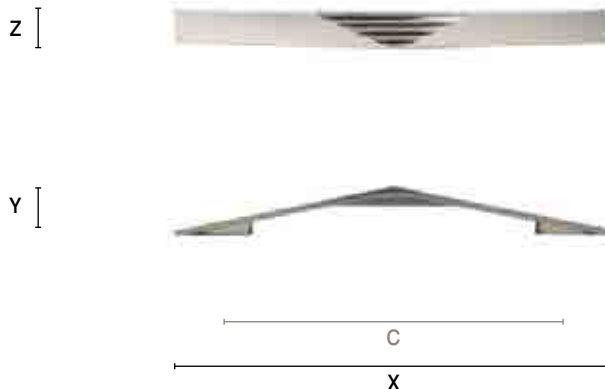

398

pag. 97

ARTICOLO ARTICLE	C INTERASSE CENTER DISTANCE	X LUNGHEZZA TOTALE TOTAL LENGTH	Z LARGHEZZA WIDTH	Y ALTEZZA HEIGHT
<b>398 B</b>	<b>160</b>	230	18	26

MATERIALE - MATERIAL zama / zamak

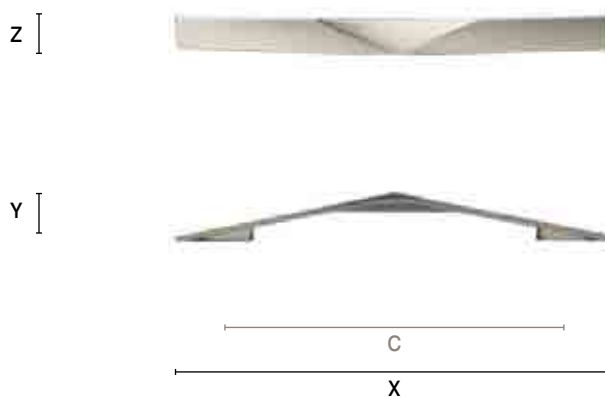

399

pag. 98

ARTICOLO ARTICLE	C INTERASSE CENTER DISTANCE	X LUNGHEZZA TOTALE TOTAL LENGTH	Z LARGHEZZA WIDTH	Y ALTEZZA HEIGHT
<b>399 B</b>	<b>160</b>	215	15	27

MATERIALE - MATERIAL zama / zamak

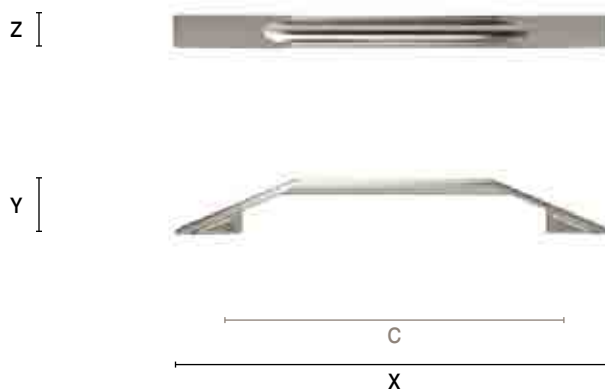

400

pag. 99

ARTICOLO ARTICLE	C INTERASSE CENTER DISTANCE	X LUNGHEZZA TOTALE TOTAL LENGTH	Z LARGHEZZA WIDTH	Y ALTEZZA HEIGHT
<b>400 A</b>	<b>320</b>	335	22	29
<b>400 B</b>	<b>160</b>	175	22	25

MATERIALE - MATERIAL zama / zamak

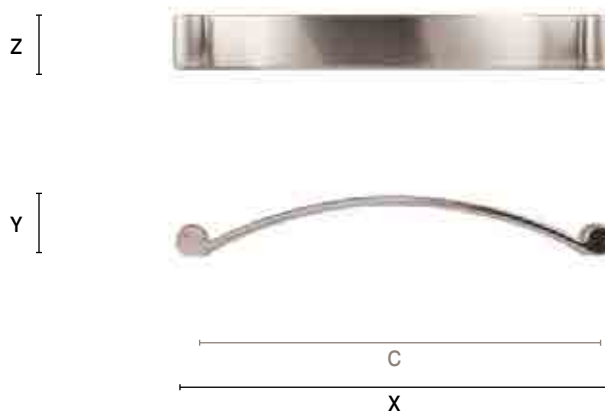

401

pag. 100

ARTICOLO ARTICLE	C INTERASSE CENTER DISTANCE	X LUNGHEZZA TOTALE TOTAL LENGTH	Z LARGHEZZA WIDTH	Y ALTEZZA HEIGHT
401 A	320	340	9	33
401 B	160	184	9	32

MATERIALE - MATERIAL zama / zamak

z



Ø 9

y



C

X

402

pag. 101

ARTICOLO ARTICLE	C INTERASSE CENTER DISTANCE	X LUNGHEZZA TOTALE TOTAL LENGTH	Z LARGHEZZA WIDTH	Y ALTEZZA HEIGHT
402 B	192	225	9	25
402 B	160	225	9	25

MATERIALE - MATERIAL zama / zamak

z



y



C

X

403

pag. 102

ARTICOLO ARTICLE	C INTERASSE CENTER DISTANCE	X LUNGHEZZA TOTALE TOTAL LENGTH	Z LARGHEZZA WIDTH	Y ALTEZZA HEIGHT
403 B	160	207	28	26

MATERIALE - MATERIAL zama / zamak

z



y



C

X

404

pag. 193

ARTICOLO ARTICLE	C INTERASSE CENTER DISTANCE	X LUNGHEZZA TOTALE TOTAL LENGTH	Z LARGHEZZA WIDTH	Y ALTEZZA HEIGHT
<b>404</b>	A RICHIESTA / ON REQUEST	-	14	34

MATERIALE PIEDINO - FOOT MATERIAL zama / zamak  
MATERIALE TUBO - BAR MATERIAL ferro / iron



405

pag. 170

ARTICOLO ARTICLE	C INTERASSE CENTER DISTANCE	X LUNGHEZZA TOTALE TOTAL LENGTH	Z LARGHEZZA WIDTH	Y ALTEZZA HEIGHT
<b>405 B</b>	<b>160</b>	180	40	17

MATERIALE - MATERIAL alluminio-zama / aluminium-zamak

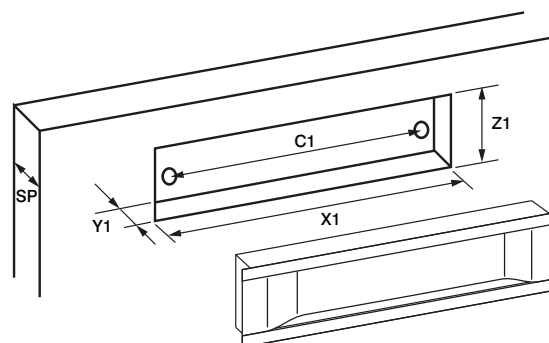
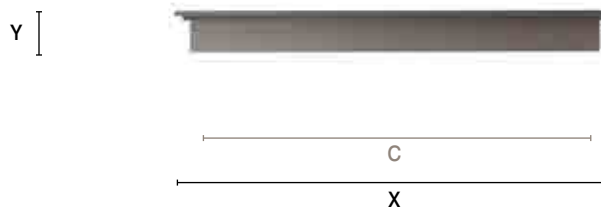

<b>SP</b>	MINIMO SPESSORE ANTA PER MONTAGGIO MINIMUM DOOR DEPTH	18
<b>C1</b>	INTERASSE CENTER DISTANCE	160
<b>X1</b>	LUNGHEZZA FRESATA TOTAL LENGTH OF THE DOOR GROOVE	178
<b>Z1</b>	LARGHEZZA FRESATA TOTAL WIDTH OF THE DOOR GROOVE	38
<b>Y1</b>	ALTEZZA FRESATA TOTAL HEIGHT OF THE DOOR GROOVE	16

406

pag. 103

ARTICOLO ARTICLE	C INTERASSE CENTER DISTANCE	X LUNGHEZZA TOTALE TOTAL LENGTH	Z LARGHEZZA WIDTH	Y ALTEZZA HEIGHT
406 B	160	177	30	25
406 c	96	108	30	25

MATERIALE - MATERIAL zama / zamak



1017

pag. 218

ARTICOLO ARTICLE	C INTERASSE CENTER DISTANCE	X LUNGHEZZA TOTALE TOTAL LENGTH	Z LARGHEZZA WIDTH	Y ALTEZZA HEIGHT
1017	96	120	25	28

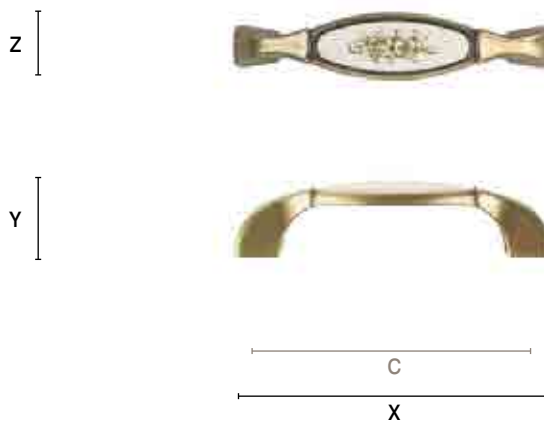
MATERIALE - MATERIAL zama-plastica / zamak-plastic  
DECORO - FLORAL PATTERN N neutro / no pattern B blu / blue O oro / gold

1018

pag. 220

ARTICOLO ARTICLE	C INTERASSE CENTER DISTANCE	X LUNGHEZZA TOTALE TOTAL LENGTH	Z LARGHEZZA WIDTH	Y ALTEZZA HEIGHT
1018	128	150	28	30

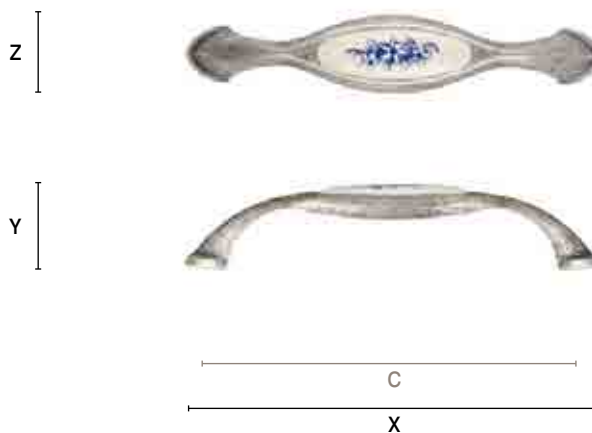
MATERIALE - MATERIAL zama-plastica / zamak-plastic  
DECORO - FLORAL PATTERN N neutro / no pattern B blu / blue O oro / gold

1019

pag. 223

ARTICOLO ARTICLE	C INTERASSE CENTER DISTANCE	X LUNGHEZZA TOTALE TOTAL LENGTH	Z LARGHEZZA WIDTH	Y ALTEZZA HEIGHT
1019 B	128	142	20	27
1019 c	96	110	17	26

MATERIALE - MATERIAL zama / zamak

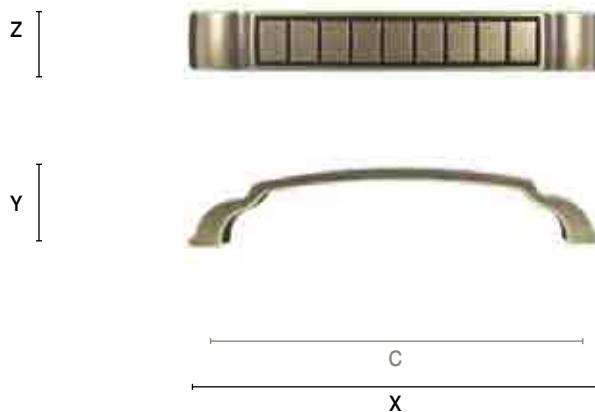

1020

pag. 225

ARTICOLO ARTICLE	C INTERASSE CENTER DISTANCE	X LUNGHEZZA TOTALE TOTAL LENGTH	Z LARGHEZZA WIDTH	Y ALTEZZA HEIGHT
1020 B	128	160	24	26
1020 c	96	127	23	26

MATERIALE - MATERIAL zama / zamak

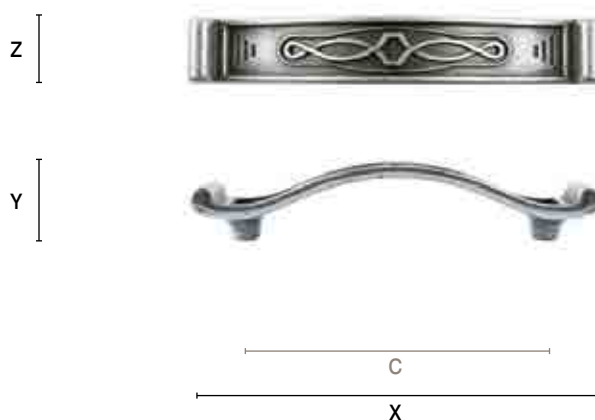

1021

pag. 226

ARTICOLO ARTICLE	C INTERASSE CENTER DISTANCE	X LUNGHEZZA TOTALE TOTAL LENGTH	Z LARGHEZZA WIDTH	Y ALTEZZA HEIGHT
1021 A	160	182	35	21
1021 A - K	160	182	35	21
1021	96	109	33	20
1021 K	96	109	33	20

MATERIALE - MATERIAL zama / zamak

K = CON CRISTALLI SWAROVSKI / WITH SWAROVSKI CRYSTALS

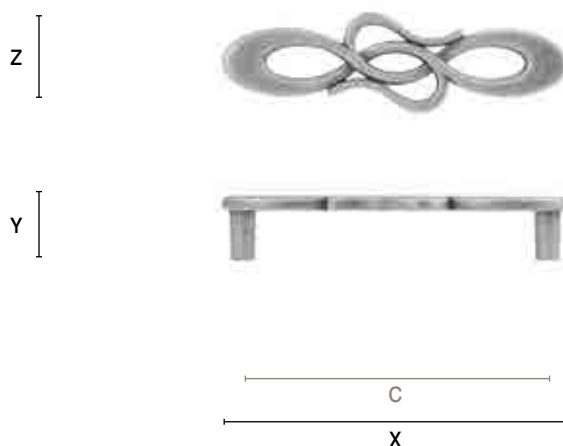



1022

pag. 229

ARTICOLO ARTICLE	C INTERASSE CENTER DISTANCE	X LUNGHEZZA TOTALE TOTAL LENGTH	Z LARGHEZZA WIDTH	Y ALTEZZA HEIGHT
<b>1022</b>	<b>96</b>	110	31	21

MATERIALE - MATERIAL zama / zamak

z



y



c

x

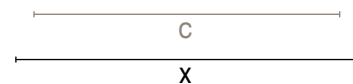

1023

pag. 230

ARTICOLO ARTICLE	C INTERASSE CENTER DISTANCE	X LUNGHEZZA TOTALE TOTAL LENGTH	Z LARGHEZZA WIDTH	Y ALTEZZA HEIGHT
<b>1023</b>	<b>96</b>	125	19	26

MATERIALE - MATERIAL zama / zamak

z



y



c

x

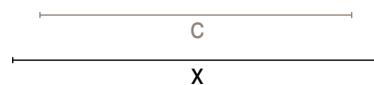

1024

pag. 231

ARTICOLO ARTICLE	C INTERASSE CENTER DISTANCE	X LUNGHEZZA TOTALE TOTAL LENGTH	Z LARGHEZZA WIDTH	Y ALTEZZA HEIGHT
<b>1024 B</b>	<b>96</b>	118	16	25

MATERIALE - MATERIAL zama / zamak

z



y



c

x

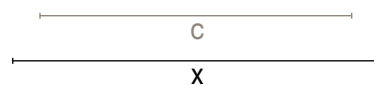

1025

pag. 232

ARTICOLO ARTICLE	C INTERASSE CENTER DISTANCE	X LUNGHEZZA TOTALE TOTAL LENGTH	Z LARGHEZZA WIDTH	Y ALTEZZA HEIGHT
1025 B	128	172	28	27
1025 c	96	132	25	26

MATERIALE - MATERIAL zama / zamak

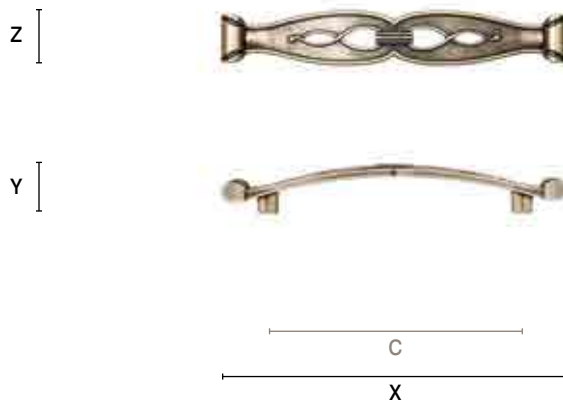

1026

pag. 233

ARTICOLO ARTICLE	C INTERASSE CENTER DISTANCE	X LUNGHEZZA TOTALE TOTAL LENGTH	Z LARGHEZZA WIDTH	Y ALTEZZA HEIGHT
1026 B	128	175	29	31
1026 c	96	133	29	31

MATERIALE - MATERIAL zama / zamak

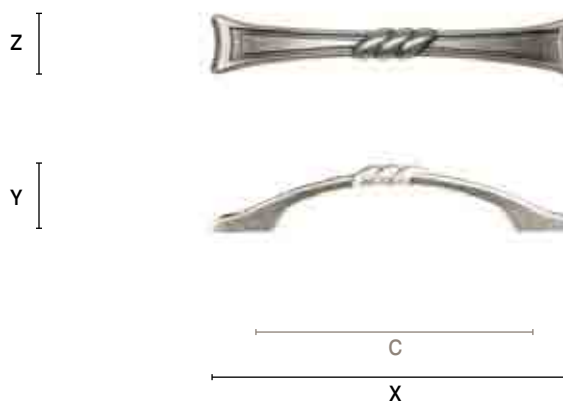

1027

pag. 234

ARTICOLO ARTICLE	C INTERASSE CENTER DISTANCE	X LUNGHEZZA TOTALE TOTAL LENGTH	Z LARGHEZZA WIDTH	Y ALTEZZA HEIGHT
1027 B - K	160	180	20	27
1027 c - K	96	118	16	23

MATERIALE - MATERIAL zama / zamak

K = CON CRISTALLI SWAROVSKI / WITH SWAROVSKI CRYSTALS

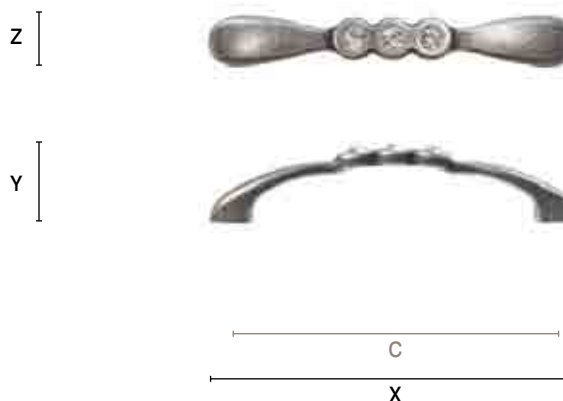

1028

pag. 236

ARTICOLO ARTICLE	C INTERASSE CENTER DISTANCE	X LUNGHEZZA TOTALE TOTAL LENGTH	Z LARGHEZZA WIDTH	Y ALTEZZA HEIGHT
1028 B	128	162	25	24
1028 c	96	127	24	24

MATERIALE - MATERIAL zama / zamak

Z



Y



C

X

1029

pag. 237

ARTICOLO ARTICLE	C INTERASSE CENTER DISTANCE	X LUNGHEZZA TOTALE TOTAL LENGTH	Z LARGHEZZA WIDTH	Y ALTEZZA HEIGHT
1029 B	128	145	23	27
1029 c	96	114	21	25

MATERIALE - MATERIAL zama / zamak

Z



Y



C

X

1030

pag. 239

ARTICOLO ARTICLE	C INTERASSE CENTER DISTANCE	X LUNGHEZZA TOTALE TOTAL LENGTH	Z LARGHEZZA WIDTH	Y ALTEZZA HEIGHT
1030 B	128	172	69	22

MATERIALE - MATERIAL zama / zamak

Z



Y



C

X

1031

pag. 239

ARTICOLO ARTICLE	C INTERASSE CENTER DISTANCE	X LUNGHEZZA TOTALE TOTAL LENGTH	Z LARGHEZZA WIDTH	Y ALTEZZA HEIGHT
1031 B	96	167	46	22

MATERIALE - MATERIAL zama / zamak

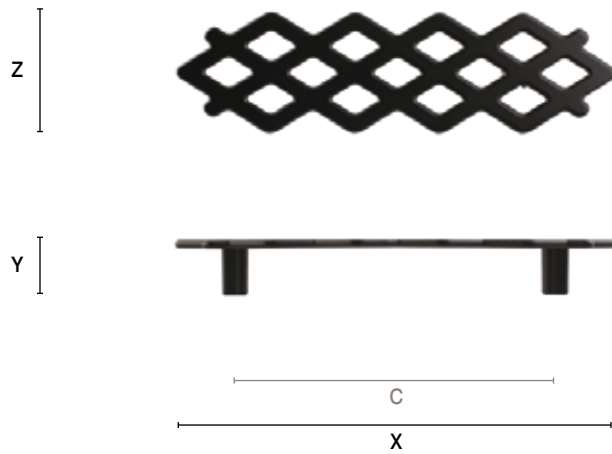

1032

pag. 241

ARTICOLO ARTICLE	C INTERASSE CENTER DISTANCE	X LUNGHEZZA TOTALE TOTAL LENGTH	Z LARGHEZZA WIDTH	Y ALTEZZA HEIGHT
1032 c	96	144	44	23

MATERIALE - MATERIAL zama / zamak

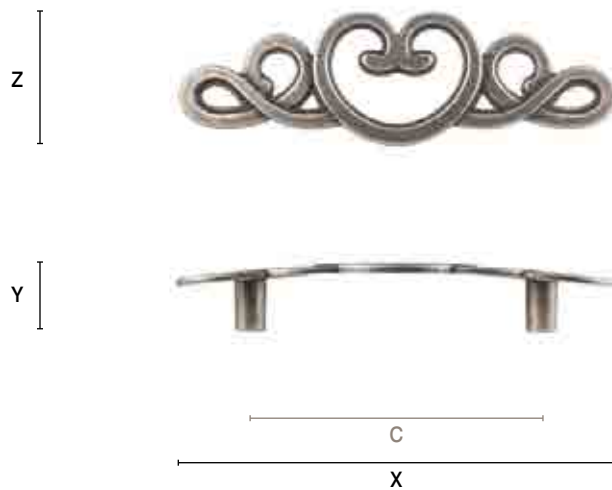

2004

pag. 202

ARTICOLO ARTICLE	C INTERASSE CENTER DISTANCE	Ø DIAMETRO DIAMETER	Y ALTEZZA HEIGHT
2004	-	12	18

MATERIALE - MATERIAL ottone / brass



2005

pag. 202

ARTICOLO ARTICLE	C INTERASSE CENTER DISTANCE	Ø DIAMETRO DIAMETER	Y ALTEZZA HEIGHT
2005	-	13	18

MATERIALE - MATERIAL *ottone / brass*

Ø

Y



2006

pag. 202

ARTICOLO ARTICLE	C INTERASSE CENTER DISTANCE	Ø DIAMETRO DIAMETER	Y ALTEZZA HEIGHT
2006	-	8	23

MATERIALE - MATERIAL *ottone / brass*

Ø

Y



2007

pag. 202

ARTICOLO ARTICLE	C INTERASSE CENTER DISTANCE	Ø DIAMETRO DIAMETER	Y ALTEZZA HEIGHT
2007	-	18	24

MATERIALE - MATERIAL *ottone / brass*

Ø

Y



2008

pag. 203

ARTICOLO ARTICLE	C INTERASSE CENTER DISTANCE	Ø DIAMETRO DIAMETER	Y ALTEZZA HEIGHT
2008	-	14	20

MATERIALE - MATERIAL *ottone / brass*

Ø

Y



2009

pag. 203

ARTICOLO ARTICLE	C INTERASSE CENTER DISTANCE	Ø DIAMETRO DIAMETER	Y ALTEZZA HEIGHT
2009	-	15	17

MATERIALE - MATERIAL *ottone / brass*

Ø

Y



2010

pag. 203

ARTICOLO ARTICLE	C INTERASSE CENTER DISTANCE	Ø DIAMETRO DIAMETER	Y ALTEZZA HEIGHT
2010 A	-	25	30
2010 B	-	20	25
2010 c	-	15	19

MATERIALE - MATERIAL *ottone / brass*

Ø

Y



2011

pag. 203

ARTICOLO ARTICLE	C INTERASSE CENTER DISTANCE	Ø DIAMETRO DIAMETER	Y ALTEZZA HEIGHT
2011	-	25	25

MATERIALE - MATERIAL zama / zamak

Ø



Y



2014

pag. 246

ARTICOLO ARTICLE	C INTERASSE CENTER DISTANCE	Ø DIAMETRO DIAMETER	Y ALTEZZA HEIGHT
2014 B	-	25	21
2014 c	-	20	19

MATERIALE - MATERIAL zama / zamak

Ø



Y



2021

pag. 246

ARTICOLO ARTICLE	C INTERASSE CENTER DISTANCE	Ø DIAMETRO DIAMETER	Y ALTEZZA HEIGHT
2021 B	-	30	16
2021 c	-	24	15

MATERIALE - MATERIAL zama / zamak

Ø



Y



2022

pag. 247

ARTICOLO ARTICLE	C INTERASSE CENTER DISTANCE	X LUNGHEZZA TOTALE TOTAL LENGTH	Z LARGHEZZA WIDTH	Y ALTEZZA HEIGHT
2022	-	33	20	20

MATERIALE - MATERIAL zama / zamak

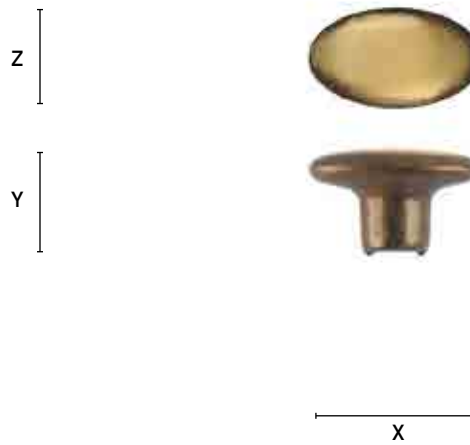

2023

pag. 246

ARTICOLO ARTICLE	C INTERASSE CENTER DISTANCE	Ø DIAMETRO DIAMETER	Y ALTEZZA HEIGHT
2023 B	-	30	21
2023 c	-	24	21

MATERIALE - MATERIAL zama / zamak



2024

pag. 246

ARTICOLO ARTICLE	C INTERASSE CENTER DISTANCE	Ø DIAMETRO DIAMETER	Y ALTEZZA HEIGHT
2024	-	30	26

MATERIALE - MATERIAL zama / zamak





2025

pag. 247

ARTICOLO ARTICLE	C INTERASSE CENTER DISTANCE	X LUNGHEZZA TOTALE TOTAL LENGTH	Z LARGHEZZA WIDTH	Y ALTEZZA HEIGHT
2025	-	33	20	19

MATERIALE - MATERIAL zama / zamak

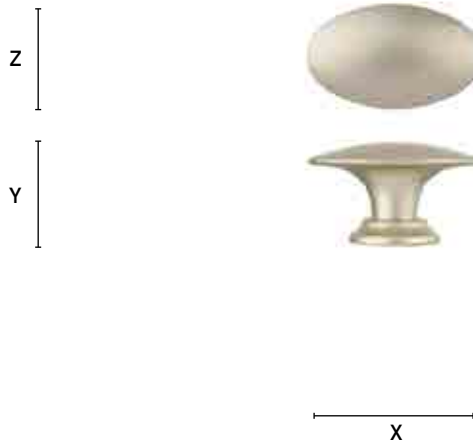

2026

pag. 247

ARTICOLO ARTICLE	C INTERASSE CENTER DISTANCE	Ø DIAMETRO DIAMETER	Y ALTEZZA HEIGHT
2026 A	-	32	26
2026 B	-	28	25
2026 C	-	25	20

MATERIALE - MATERIAL ottone / brass



2027

pag. 218

ARTICOLO ARTICLE	C INTERASSE CENTER DISTANCE	Ø DIAMETRO DIAMETER	Y ALTEZZA HEIGHT
2027	-	40	26

MATERIALE - MATERIAL zama / zamak

DECORO - FLORAL PATTERN N neutro / no pattern B blu / blue O oro / gold



2028

pag. 221

ARTICOLO ARTICLE	C INTERASSE CENTER DISTANCE	X LUNGHEZZA TOTALE TOTAL LENGTH	Z LARGHEZZA WIDTH	Y ALTEZZA HEIGHT
2028	-	54	30	25

MATERIALE - MATERIAL zama / zamak

DECORO - FLORAL PATTERN N neutro / no pattern B blu / blue O oro / gold

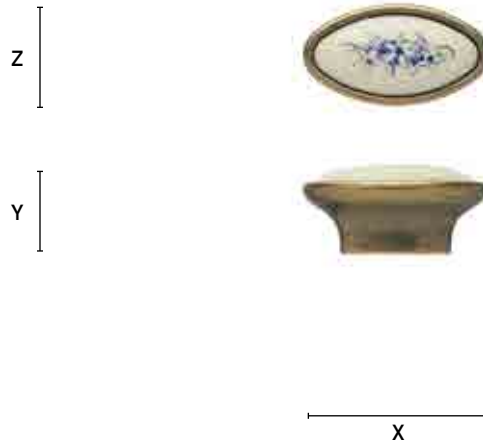

2029

pag. 205

ARTICOLO ARTICLE	C INTERASSE CENTER DISTANCE	Ø DIAMETRO DIAMETER	Y ALTEZZA HEIGHT
2029	-	15	20

MATERIALE - MATERIAL ottone / brass - legno / wood



2030

pag. 204

ARTICOLO ARTICLE	C INTERASSE CENTER DISTANCE	Ø DIAMETRO DIAMETER	Y ALTEZZA HEIGHT
2030	-	15	20

MATERIALE - MATERIAL ottone / brass



2031

pag. 204

ARTICOLO ARTICLE	C INTERASSE CENTER DISTANCE	Ø DIAMETRO DIAMETER	Y ALTEZZA HEIGHT
2031	-	16	19

MATERIALE - MATERIAL *ottone / brass*

Ø

Y



2032

pag. 210

ARTICOLO ARTICLE	C INTERASSE CENTER DISTANCE	X LUNGHEZZA TOTALE TOTAL LENGTH	Z LARGHEZZA WIDTH	Y ALTEZZA HEIGHT
2032	16	53	53	26

MATERIALE - MATERIAL *zama / zamak*

Z

Y



C

X

2033

pag. 208

ARTICOLO ARTICLE	C INTERASSE CENTER DISTANCE	X LUNGHEZZA TOTALE TOTAL LENGTH	Z LARGHEZZA WIDTH	Y ALTEZZA HEIGHT
2033	16	50	50	26

MATERIALE - MATERIAL *zama / zamak*

Z

Y

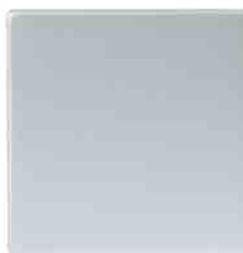

C

X

2034

pag. 204

ARTICOLO ARTICLE	C INTERASSE CENTER DISTANCE	Ø DIAMETRO DIAMETER	Y ALTEZZA HEIGHT
2034	-	12	18

MATERIALE - MATERIAL *ottone / brass*

Ø

Y



2035

pag. 204

ARTICOLO ARTICLE	C INTERASSE CENTER DISTANCE	Ø DIAMETRO DIAMETER	Y ALTEZZA HEIGHT
2035	-	15	20

MATERIALE - MATERIAL *ottone / brass*

Ø

Y



2036

pag. 208

ARTICOLO ARTICLE	C INTERASSE CENTER DISTANCE	X LUNGHEZZA TOTALE TOTAL LENGTH	Z LARGHEZZA WIDTH	Y ALTEZZA HEIGHT
2036	16	35	35	23

MATERIALE - MATERIAL *zama / zamak*

Z

Y

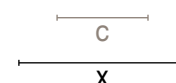

2037

pag. 209

ARTICOLO ARTICLE	C INTERASSE CENTER DISTANCE	X LUNGHEZZA TOTALE TOTAL LENGTH	Z LARGHEZZA WIDTH	Y ALTEZZA HEIGHT
2037	16	50	50	15

MATERIALE - MATERIAL zama / zamak

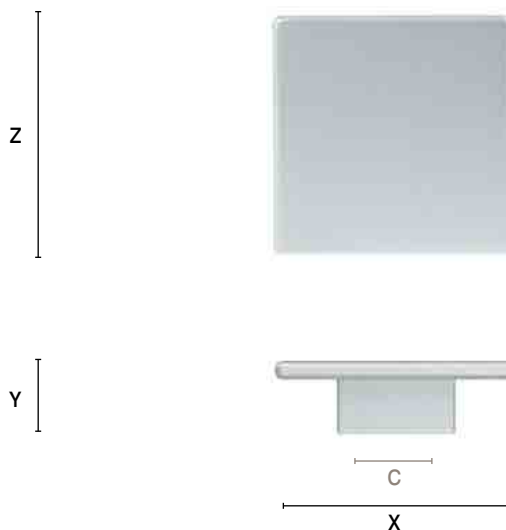

2038

pag. 205

ARTICOLO ARTICLE	C INTERASSE CENTER DISTANCE	X LUNGHEZZA TOTALE TOTAL LENGTH	Z LARGHEZZA WIDTH	Y ALTEZZA HEIGHT
2038	-	15	15	27

MATERIALE - MATERIAL zama / zamak

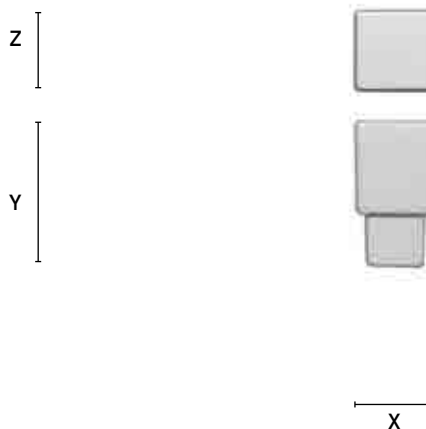

2039

pag. 222

ARTICOLO ARTICLE	C INTERASSE CENTER DISTANCE	X LUNGHEZZA TOTALE TOTAL LENGTH	Z LARGHEZZA WIDTH	Y ALTEZZA HEIGHT
2039	16	35	35	24

MATERIALE - MATERIAL zama / zamak

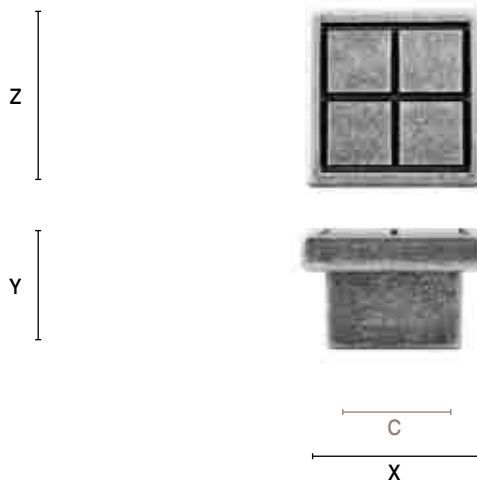

2040

pag. 224

ARTICOLO ARTICLE	C INTERASSE CENTER DISTANCE	X LUNGHEZZA TOTALE TOTAL LENGTH	Z LARGHEZZA WIDTH	Y ALTEZZA HEIGHT
<b>2040</b>	<b>16</b>	35	35	24

MATERIALE - MATERIAL zama / zamak

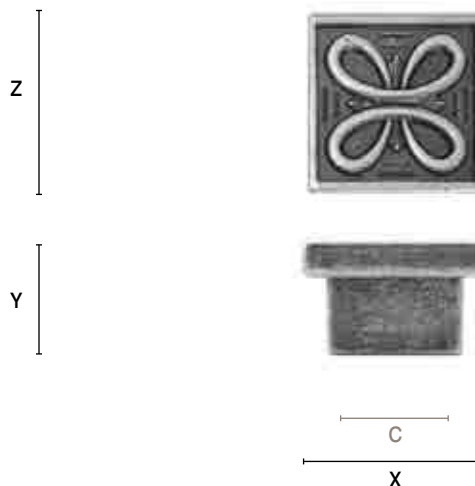

2041

pag. 211

ARTICOLO ARTICLE	C INTERASSE CENTER DISTANCE	X LUNGHEZZA TOTALE TOTAL LENGTH	Z LARGHEZZA WIDTH	Y ALTEZZA HEIGHT
<b>2041 B</b>	<b>32</b>	80	80	21
<b>2041 c</b>	<b>32</b>	50	50	21

MATERIALE - MATERIAL zama / zamak

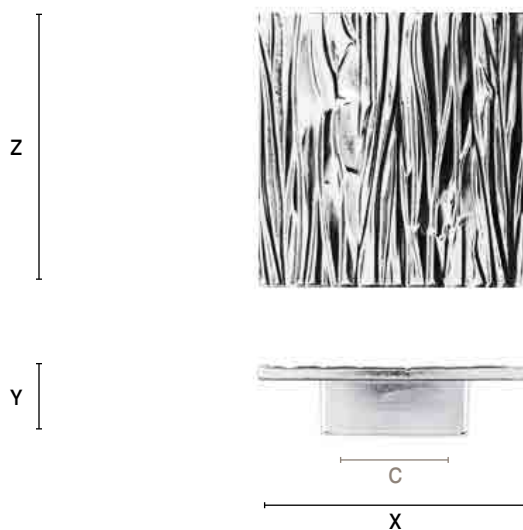

2042

pag. 207

ARTICOLO ARTICLE	C INTERASSE CENTER DISTANCE	X LUNGHEZZA TOTALE TOTAL LENGTH	Z LARGHEZZA WIDTH	Y ALTEZZA HEIGHT
<b>2042</b>	<b>16</b>	50	50	26

MATERIALE - MATERIAL zama / zamak

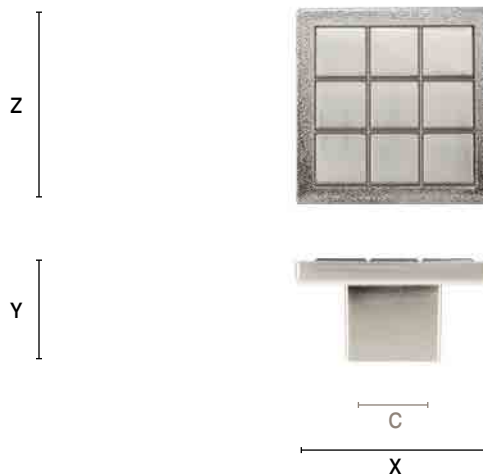

2043

pag. 207

ARTICOLO ARTICLE	C INTERASSE CENTER DISTANCE	X LUNGHEZZA TOTALE TOTAL LENGTH	Z LARGHEZZA WIDTH	Y ALTEZZA HEIGHT
2043	16	41	41	25

MATERIALE - MATERIAL zama / zamak

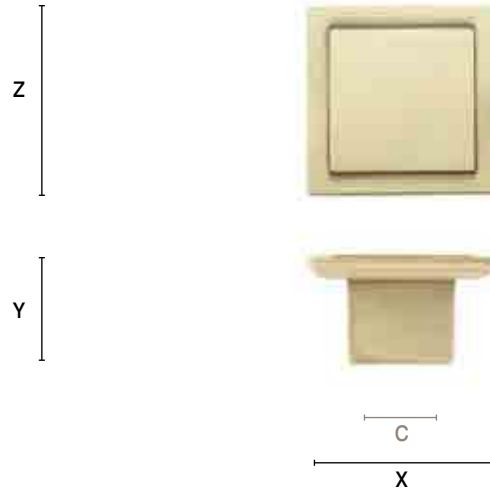

2044

pag. 228

ARTICOLO ARTICLE	C INTERASSE CENTER DISTANCE	Ø DIAMETRO DIAMETER	Y ALTEZZA HEIGHT
2044	-	30	19
2044 K	-	30	19

MATERIALE - MATERIAL zama / zamak

**K = CON CRISTALLI SWAROVSKI / WITH SWAROVSKI CRYSTALS**



2045

pag. 210

ARTICOLO ARTICLE	C INTERASSE CENTER DISTANCE	X LUNGHEZZA TOTALE TOTAL LENGTH	Z LARGHEZZA WIDTH	Y ALTEZZA HEIGHT
2045	16	35	35	24

MATERIALE - MATERIAL zama / zamak

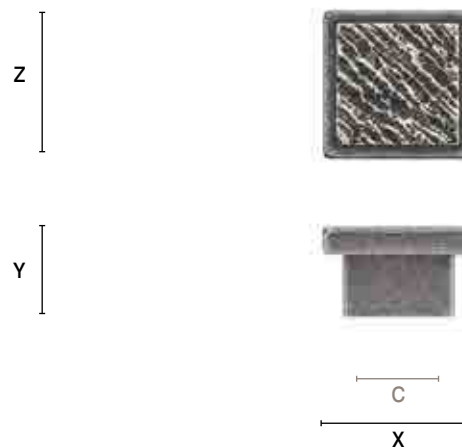

2046

pag. 232

ARTICOLO ARTICLE	C INTERASSE CENTER DISTANCE	X LUNGHEZZA TOTALE TOTAL LENGTH	Z LARGHEZZA WIDTH	Y ALTEZZA HEIGHT
2046	16	39	39	25

MATERIALE - MATERIAL zama / zamak

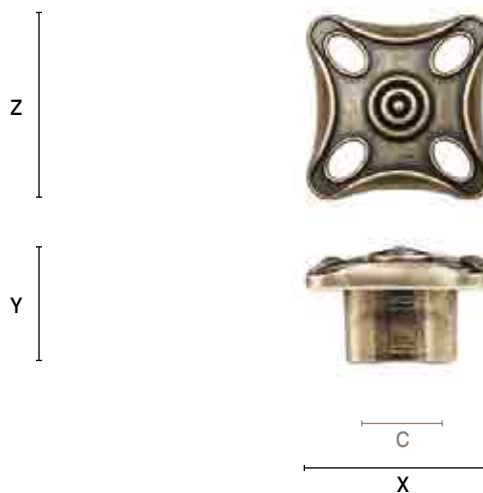

2047

pag. 235

ARTICOLO ARTICLE	C INTERASSE CENTER DISTANCE	Ø DIAMETRO DIAMETER	Y ALTEZZA HEIGHT
2047 K	-	40	25

MATERIALE - MATERIAL zama / zamak

K = CON CRISTALLI SWAROVSKI / WITH SWAROVSKI CRYSTALS



2048

pag. 212

ARTICOLO ARTICLE	C INTERASSE CENTER DISTANCE	X LUNGHEZZA TOTALE TOTAL LENGTH	Z LARGHEZZA WIDTH	Y ALTEZZA HEIGHT
2048	32	50	50	17

MATERIALE - MATERIAL zama / zamak

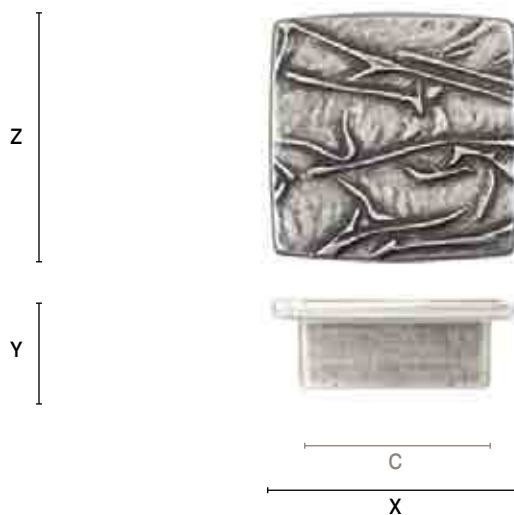



2049

pag. 213

ARTICOLO ARTICLE	C INTERASSE CENTER DISTANCE	Ø DIAMETRO DIAMETER	Y ALTEZZA HEIGHT
2049 K	-	15	20

MATERIALE - MATERIAL ottone / brass

K = CON CRISTALLI SWAROVSKI / WITH SWAROVSKI CRYSTALS



2050

pag. 237

ARTICOLO ARTICLE	C INTERASSE CENTER DISTANCE	Ø DIAMETRO DIAMETER	Y ALTEZZA HEIGHT
2050	-	39	22

MATERIALE - MATERIAL zama / zamak



2051

pag. 238

ARTICOLO ARTICLE	C INTERASSE CENTER DISTANCE	X LUNGHEZZA TOTALE TOTAL LENGTH	Z LARGHEZZA WIDTH	Y ALTEZZA HEIGHT
2051	-	71	46	22

MATERIALE - MATERIAL zama / zamak

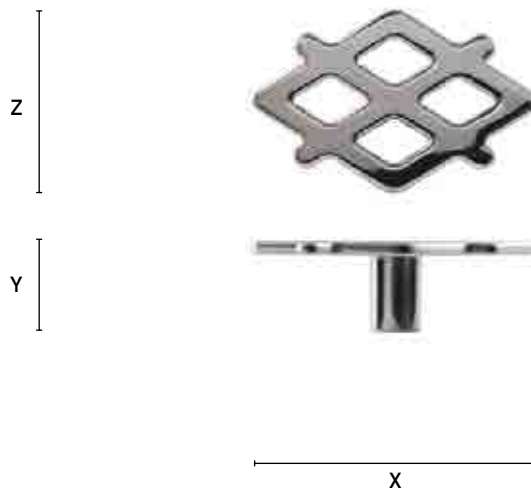

2052

pag. 214

ARTICOLO ARTICLE	C INTERASSE CENTER DISTANCE	Ø DIAMETRO DIAMETER	Y ALTEZZA HEIGHT
2052 A	-	80	22
2052 B	-	50	19

MATERIALE - MATERIAL zama / zamak



2053

pag. 240

ARTICOLO ARTICLE	C INTERASSE CENTER DISTANCE	Ø DIAMETRO DIAMETER	Y ALTEZZA HEIGHT
1030 B	-	34	20

MATERIALE - MATERIAL zama / zamak



5000

pag. 194

ARTICOLO ARTICLE	C INTERASSE CENTER DISTANCE	X LUNGHEZZA TOTALE TOTAL LENGTH	Z LARGHEZZA WIDTH	Y ALTEZZA HEIGHT
5000	A RICHIESTA / ON REQUEST	A RICHIESTA / ON REQUEST	8	20

MATERIALE - MATERIAL alluminio / aluminium



5001

pag. 194

ARTICOLO ARTICLE	<b>C</b> INTERASSE CENTER DISTANCE	<b>X</b> LUNGHEZZA TOTALE TOTAL LENGTH	<b>Z</b> LARGHEZZA WIDTH	<b>Y</b> ALTEZZA HEIGHT
---------------------	--	--	--------------------------------	-------------------------------

<b>5001</b>	A RICHIESTA / ON REQUEST	A RICHIESTA / ON REQUEST	13	18
-------------	--------------------------	--------------------------	----	----

MATERIALE - MATERIAL alluminio / aluminium

z |



y |



5002

pag. 194

ARTICOLO ARTICLE	<b>C</b> INTERASSE CENTER DISTANCE	<b>X</b> LUNGHEZZA TOTALE TOTAL LENGTH	<b>Z</b> LARGHEZZA WIDTH	<b>Y</b> ALTEZZA HEIGHT
---------------------	--	--	--------------------------------	-------------------------------

<b>5002</b>	A RICHIESTA / ON REQUEST	A RICHIESTA / ON REQUEST	10	18
-------------	--------------------------	--------------------------	----	----

MATERIALE - MATERIAL alluminio / aluminium

z |



y |



5003

pag. 194

ARTICOLO ARTICLE	<b>C</b> INTERASSE CENTER DISTANCE	<b>X</b> LUNGHEZZA TOTALE TOTAL LENGTH	<b>Z</b> LARGHEZZA WIDTH	<b>Y</b> ALTEZZA HEIGHT
---------------------	--	--	--------------------------------	-------------------------------

<b>5003</b>	A RICHIESTA / ON REQUEST	A RICHIESTA / ON REQUEST	13	18
-------------	--------------------------	--------------------------	----	----

MATERIALE - MATERIAL alluminio / aluminium

z |



y |



S8085

pag. 171

ARTICOLO ARTICLE	C INTERASSE CENTER DISTANCE	X LUNGHEZZA TOTALE TOTAL LENGTH	Z LARGHEZZA WIDTH	Y ALTEZZA HEIGHT
S8085 A	170	178	36,5	18
S8085 B	113	124	28	14

MATERIALE - MATERIAL zama / zamak

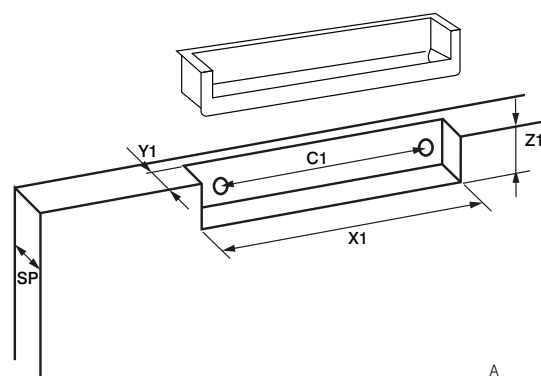
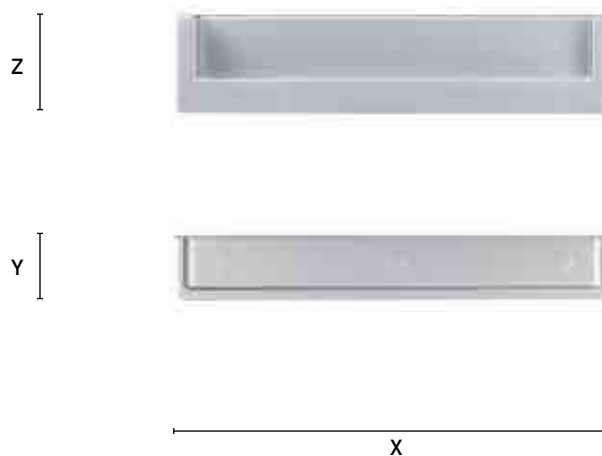

	A	B
<b>SP</b> MINIMO SPESSORE ANTA PER MONTAGGIO MINIMUM DOOR DEPTH	22	19
<b>C1</b> INTERASSE CENTER DISTANCE	170	113
<b>X1</b> LUNGHEZZA FRESATA TOTAL LENGTH OF THE DOOR GROOVE	176	121
<b>Z1</b> LARGHEZZA FRESATA TOTAL WIDTH OF THE DOOR GROOVE	33	25
<b>Y1</b> ALTEZZA FRESATA TOTAL HEIGHT OF THE DOOR GROOVE	18	14

S8087

pag. 242

ARTICOLO ARTICLE	C INTERASSE CENTER DISTANCE	X LUNGHEZZA TOTALE TOTAL LENGTH	Z LARGHEZZA WIDTH	Y ALTEZZA HEIGHT
S8087	96	110	20	24

MATERIALE - MATERIAL zama / zamak



# S8102

pag. 206

ARTICOLO ARTICLE	C INTERASSE CENTER DISTANCE	Ø DIAMETRO DIAMETER	Y ALTEZZA HEIGHT
<b>S8102</b>	-	12	25

MATERIALE - MATERIAL ottone / brass

Ø

Y



# S8103

pag. 206

ARTICOLO ARTICLE	C INTERASSE CENTER DISTANCE	Ø DIAMETRO DIAMETER	Y ALTEZZA HEIGHT
<b>S8103</b>	-	12	21

MATERIALE - MATERIAL ottone / brass

Ø

Y



# S8105

pag. 243

ARTICOLO ARTICLE	C INTERASSE CENTER DISTANCE	X LUNGHEZZA TOTALE TOTAL LENGTH	Z LARGHEZZA WIDTH	Y ALTEZZA HEIGHT
<b>S8105</b>	-	67	47	25
<b>S8105 K</b>	-	67	47	25

MATERIALE - MATERIAL zama / zamak

K = CON CRISTALLI SWAROVSKI / WITH SWAROVSKI CRYSTALS

Z

Y



X

S8107

pag. 244

ARTICOLO ARTICLE	C INTERASSE CENTER DISTANCE	X LINGHEZZA TOTALE TOTAL LENGTH	Z LARGHEZZA WIDTH	Y ALTEZZA HEIGHT
<b>S8107</b>	<b>128</b>	135	20	24

MATERIALE - MATERIAL zama / zamak



S8108

pag. 244

ARTICOLO ARTICLE	C INTERASSE CENTER DISTANCE	X LINGHEZZA TOTALE TOTAL LENGTH	Z LARGHEZZA WIDTH	Y ALTEZZA HEIGHT
<b>S8108</b>	<b>128</b>	135	20	24

MATERIALE - MATERIAL ottone / brass

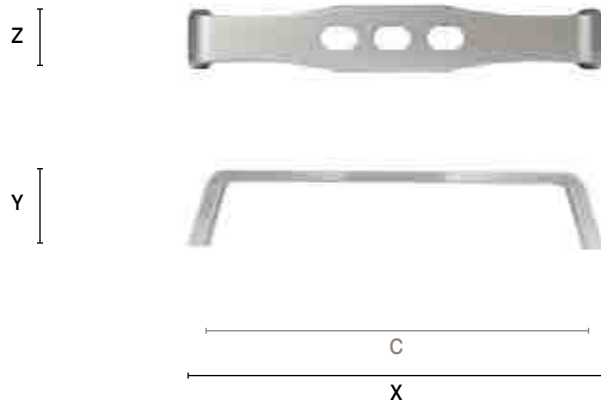

S8109

pag. 172

ARTICOLO ARTICLE	<b>C</b> INTERASSE CENTER DISTANCE	<b>X</b> LUNGHEZZA TOTALE TOTAL LENGTH	<b>Z</b> LARGHEZZA WIDTH	<b>Y</b> ALTEZZA HEIGHT
<b>S8109</b>	<b>55</b>	68	19	13

MATERIALE - MATERIAL *ottone / brass*

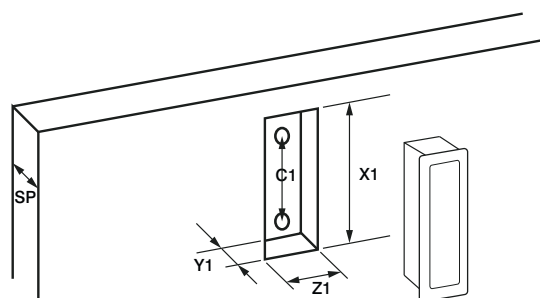
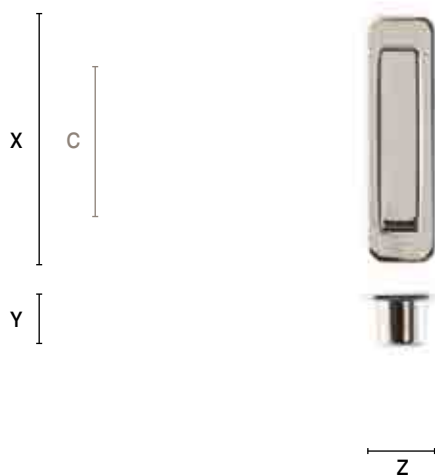

<b>SP</b>	MINIMO SPESSORE ANTA PER MONTAGGIO MINIMUM DOOR DEPTH	13
<b>C1</b>	INTERASSE CENTER DISTANCE	55
<b>X1</b>	LUNGHEZZA FRESATA TOTAL LENGTH OF THE DOOR GROOVE	63
<b>Z1</b>	LARGHEZZA FRESATA TOTAL WIDTH OF THE DOOR GROOVE	15
<b>Y1</b>	ALTEZZA FRESATA TOTAL HEIGHT OF THE DOOR GROOVE	12

**citterio**line 

---

# FINISHES



# FINISHES

GALVANICHE  
GALVANISED

04



**ARGENTO LUCIDO**  
bright silver

05



**ARGENTO OPACO**  
matt silver

09



**ARGENTO ANTICO**  
antique silver

10



**CROMO LUCIDO**  
bright chrome

11



**NICHEL SATINATO**  
satin nickel

11/V



**NICHEL VECCHIO**  
old nickel

14



**NICHEL NERO**  
black nickel

14/S



**NICHEL NERO SATINATO**  
satin black nickel

15



**OTTONE LUCIDO**  
bright brass

17



**ORO ZECCHINO**  
gold plated 24kt

18



**RAME LUCIDO**  
bright copper

18/L



**RAME SATINATO LUCIDO**  
satin bright copper

18/S



**RAME SATINATO NERO**  
satin black copper

19



**PELTRO SATINATO OPACO**  
satin matt pewter

19/S



**PELTRO SFUMATO OPACO**  
shaded matt pewter

20



**BRONZO SATINATO**  
satin bronze

22



**BRONZO LUCIDO**  
bright bronze

23



**BRONZO OPACO**  
matt bronze



**24**  
**BRONZO ANTICATO FRANCESE**  
antique french bronze



**25/18**  
**BRONZO SU RAME**  
copper-plated bronze



**100**  
**GOMMA**  
gummy



**101**  
**LAVAGNA**  
lavastone



**102**  
**SABBIATO**  
sandblasted



**103**  
**NIKEL NERO GRAFFIATO**  
scratched black nickel

I colori riferiti alle finiture sono puramente indicativi.  
*Colours referred to finishes are merely indicative.*

È possibile avere su richiesta finiture speciali.  
*Special finishes are available on request.*

# FINISHES

LACCATE  
LACQUERED

31

CROMO OPACO  
matt chrome

32

CROMO LUCIDO  
bright chrome

33

NICHEL OPACO  
matt nickel

51

NERO LUCIDO/POLVERE  
bright black/epoxy

52

NERO OPACO  
matt black

54

BIANCO LUCIDO/POLVERE  
bright white/epoxy

71

BIANCO OPACO  
matt white

69

TITANIO  
titanium

75

PIOMBO  
plumb-coloured

76

ORO OPACO  
matt gold

76/S

ORO OPACO SATINATO  
satin matt gold

77

NEVER PELTRO  
never peltro

LACCATE  
SPECIALI  
SPECIAL  
LACQUERED

300

RAME ROSA SATINATO  
satin rose copper

301

RAME ROSSO SATINATO  
satin red copper

302

BLU ACCIAIO SATINATO  
satin blue inox

303

VERDE BRONZO SATINATO  
satin green bronze

PELLE  
LEATHER

200

COLOR NATURALE  
natural-coloured

201

COLOR CAFFÈ  
coffee-coloured

202

COLOR BRANDY  
brandy-coloured

203

COLOR PRUGNA  
plum-coloured

ANODIZATE  
ANODIZED

01

OXY BRILL  
oxy brill

02

INOX SATINATO BRONZINO  
satin inox bronzino

03

ZERO CHIMICO  
zero chimico

I colori riferiti alle finiture sono puramente indicativi.  
*Colours referred to finishes are merely indicative.*

È possibile avere su richiesta finiture speciali.  
*Special finishes are available on request.*

---

Citterio Line si riserva il diritto di apportare, in qualsiasi momento, modifiche di natura tecnica o commerciale al presente catalogo senza preavviso.

I modelli Citterio Line sono tutelati da brevetto internazionale.

Le misure sono espresse in millimetri.

Gli articoli fotografati non sono in misura reale.

Citterio Line reserves the right, at any time, to make technical or commercial changes to this catalogue without any notice.

All articles are covered by international patent.

Sizes are expressed in millimeters.

Articles reproduction is not life-size.



**PROGETTO GRAFICO  
E FOTOGRAFIA**  
laboratorio di comunicazione  
[www.ladico.it](http://www.ladico.it)

Gennaio 2017





**citterio**line 

**Citterio Line Spa**

20838 Renate (MB) Italy - Via Dante Alighieri 21  
Tel. +39 0362 925 425 r.a. - Fax +39 0362 925 424  
[www.citterioline.com](http://www.citterioline.com) [info@citterioline.com](mailto:info@citterioline.com)

---