

842 00 P2 U6 2F

New

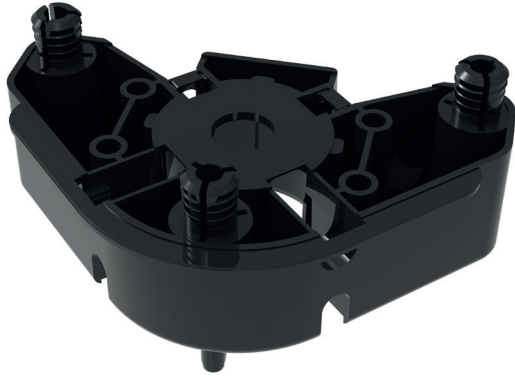

400



2400



800

