

www.dbgroupherrajes.com



FAMILIA TRES

ADVANCED / Caronte / Distanciadores / Conector fondo-frente cajón / LiniQ / SpaceLine / Tessuto / Cubetero ADVANCED / Cubetero Caronte / Cubetero Linea 462 / Cubetero Universal / Divisor interior cajón / Cover cajón ADVANCED / Antideslizante Ago Tex / Antideslizante Line Protector de cajón Textil / Protector de cajón Point / SpaceFlexx Base perforada-Pivote / Portaplatos adaptable Guía Shelf / Guía Synkron / Guía Sigma

Cajones y Organización

Hoy los cajones, se han convertido en auténticos protagonistas del mundo del herraje.

Su carácter holístico en el mobiliario moderno, que todo lo llena, ha penetrado con fuerza en los conceptos de diseño de cualquier cocina, baño e incluso armario.

Así, desde DB GROUP, proponemos la gama más interesante del mercado, que tiene como producto estrella a nuestro cajón Advanced, punta de lanza del proyecto Kautät y auténtico generador de satisfacciones.

Sin embargo, no hay buen cajón, sin una buena organización y aquí DB GROUP, cumple con creces las expectativas.

Todo tipo de materiales, diseños y acabados, para no sólo ser bueno, sino además, parecerlo



Herrajes técnicos para mobiliario

www.dbgroupherrajes.com



FAMILIA TRES

ADVANCED / Caronte / Distanciadores / Conector fondo-frente cajón / LiniQ / SpaceLine / Tessuto / Cubetero ADVANCED / Cubetero Caronte / Cubetero Linea 462 / Cubetero Universal / Divisor interior cajón / Cover cajón ADVANCED / Antideslizante Ago Tex / Antideslizante Line Protector de cajón Textil / Protector de cajón Point / SpaceFlexx Base perforada-Pivote / Portaplatos adaptable Guía Shelf / Guía Synkron / Guía Sigma



ADVANCED H87.....	88
ADVANCED H117	90
ADVANCED H167	92
ADVANCED H167 Guía 50 Kg.	94
ADVANCED H87 Guía Push	95
Frontal interior.....	97
Frontal interior personalizable	99
Laterales de cristal o personalizables	101
Set barra gaveta ADVANCED.....	103
Caronte / Set barra gaveta cuadrada.....	109
Set frontal cajon-gaveta interior	111
Distanciadores.....	112
Conector fondo-frente cajón	113
Organizador LiniQ Roble Natural	119
Organizador LiniQ Negro Ceniza.....	125
Organizador de gaveta LiniQ.....	127
Organizador de cajón SpaceLine	128
Protector de cajón antideslizante Tessuto.....	129
Cubertero ADVANCED - Complementos.....	130
Cubertero Caronte - Complementos	131
Cubertero Línea 462 - Complementos.....	132
Cubertero Universal - Complementos.....	133
Divisor interior de cajón universal	134
Cover cajón ADVANCED	135
Protector de cajón antideslizante Ago Tex / Protector de cajón antideslizante Line.....	136
Protector de cajón Textil / Protector de cajón Point	137
SpaceFlexx.....	139
Base perforada-pivote.....	140
Portaplatos adaptable	141
Guía Shelf.....	143
Guía Synkron	145
Guía Sigma.....	147

ADVÄ

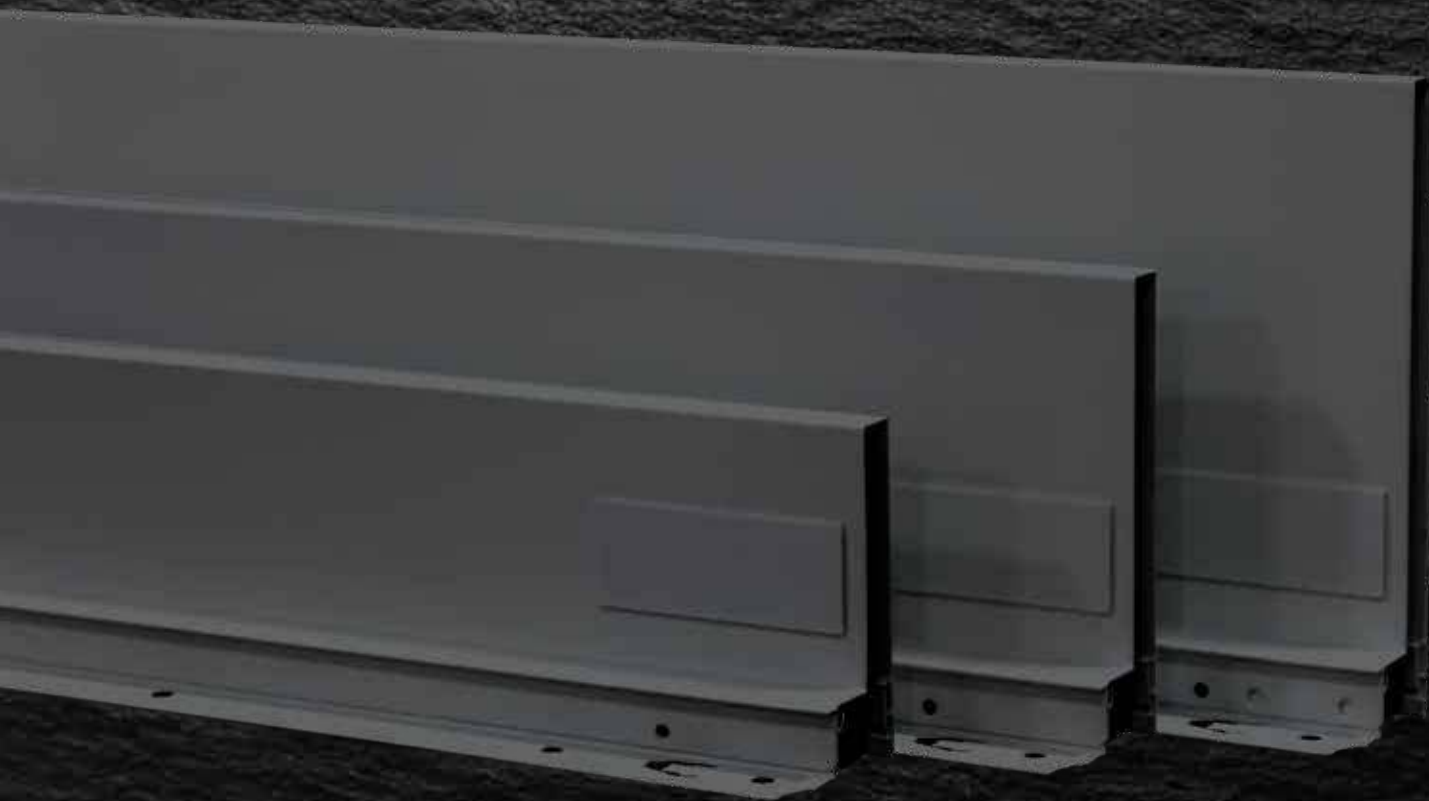

ANCED

EVOLUTION





ADVANCED H167 Blanco



ADVANCED H167 Antracita

ADVANCED

Un paso por
delante



Dossier técnico
ADVANCED

EVOLUTION

ADVANCED es el producto estrella de la marca KAÜTAT. En respuesta a las nuevas tendencias de mercado, DB GROUP pone a disposición de sus clientes un cajón de estética lineal, limpia y elegante que con su perfil fino de 13 mm., permite a su vez, disfrutar de una máxima capacidad interior del cajón o gaveta alta.

Su excelente y contrastada guía sincronizada, evita ruidos y optimiza el deslizamiento, aportando además un excelente comportamiento con carga dinámica.

ADVANCED, se presenta en dos acabados, antracita y blanco, en tres alturas 87, 117 y 167, en todos los fondos y repleto de un completo programa de accesorios, cuberteros, protectores, sistemas de reciclaje, etc. con el que poder vestir el cajón con múltiples soluciones.

ADVANCED by KAÜTAT, la apuesta solvente e inteligente.



ADVANCED H87 Blanco



KAUTÄT

Cuestión de confianza

ADVANCED se alinea con las nuevas tendencias del mercado, que reclaman laterales de cajón más estrechos, proyectando sensación de modernidad y un objetivo aprovechamiento interior, favorecido por su costado de tan solo 13 mm de grosor.

ADVANCED

EV  LUTION



ADVANCED es perfecto para la cocina. Sus diferentes alturas le permiten adaptarse con solvencia a las diversas medidas de módulos de la actualidad. Igualmente, su acabado antracita encuentra su lugar en las cocinas de tendencia, mientras que el blanco cumple su papel atemporal.

KITCHEN



Para Living o armario, **ADVANCED** es especialmente indicado. Su acabado antracita y de estética lineal, lo hacen integrarse con naturalidad a su diseño, además de otorgar un espacio superior, siempre necesario en estos mobiliarios.

CLOSET



Los diferentes fondos de **ADVANCED**, le hacen un aliado perfecto para el mueble de baño. Salvar sifones o fondos reducidos, no son un problema, menos aún, en combinación con el perfil **Libero**.



POR QUÉ ELEGIR ADVANCED

EVOLUTION



4D es el acrónimo que sitúa al cajón Advanced en una cuarta dimensión. Como elemento diferenciador de gran parte de las opciones del mercado, Advanced incluye en todas las alturas de su programa, la tercera regulación denominada de **abatimiento**. Esta regulación, permite la perfecta alineación de todos los frentes de la cocina, para conseguir un diseño y calidad de percepción de alto nivel.

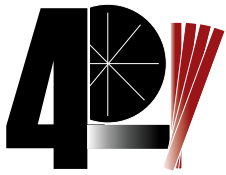

4ª Dimensión



Montaje rápido



Calidad de acabados



Diseño minimalista



3 Alturas
87 mm.
117 mm.
167 mm.



5 Fondos
300 mm.
350 mm.
400 mm.
450 mm.
500 mm.





Certificado de Calidad

SGS

100.000
ciclos de apertura

Espesores de los componentes



Freno encapsulado



Fijaciones y regulaciones 100% metálicas



2 Acabados
Antracita
Blanco

Cover y Perfil
Negro Mate Cobre
U6 Inox Oro

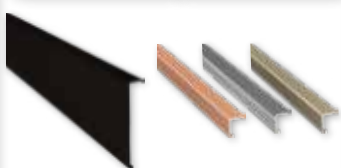
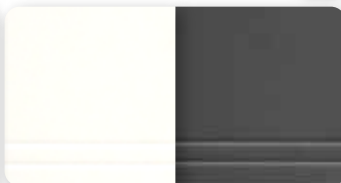

3 Tipos de guías



Laterales y frontales en acero y cristal



Protector fondo cajón en diferentes acabados



Organizador de cajones en ABS/Madera/Metálicos



Sistemas de Reciclaje





ADVANCED H87 Antracita

Código	Descripción	Alto	Fondo	Acabado	Embalaje
0306007	Kit ADVANCED H87 300	87	300	Antracita	1
0306107	Kit ADVANCED H87 350	87	350	Antracita	1
0306207	Kit ADVANCED H87 400	87	400	Antracita	1
0306307	Kit ADVANCED H87 450	87	450	Antracita	1
0306407	Kit ADVANCED H87 500	87	500	Antracita	1
0320101	Kit ADVANCED H87 300	87	300	Blanco	1
0320201	Kit ADVANCED H87 350	87	350	Blanco	1
0320301	Kit ADVANCED H87 400	87	400	Blanco	1
0320401	Kit ADVANCED H87 450	87	450	Blanco	1
0320501	Kit ADVANCED H87 500	87	500	Blanco	1
0301068	Soporte frontal ADVANCED H87 tornillo premontado+taco 10 mm.	---	---	Galvanizado	400

ADVANCED H87



Embalaje - Kit ADVANCED H87



La H87, es la primera y más demandada, para todos aquellos cajones en los que guardamos utensilios pequeños, que queremos tener siempre ordenados y a mano en un solo vistazo. Ideal para cajones de cocinas o baños, gracias a los 13 mm de grosor de costado, permite un espacio interior interesante, en el que todo está accesible en cualquier momento.



ADVANCED H117 Antracita

Código	Descripción	Alto	Fondo	Acabado	Embalaje
0306507	Kit ADVANCED H117 300	117	300	Antracita	1
0306607	Kit ADVANCED H117 350	117	350	Antracita	1
0306707	Kit ADVANCED H117 400	117	400	Antracita	1
0306807	Kit ADVANCED H117 450	117	450	Antracita	1
0306907	Kit ADVANCED H117 500	117	500	Antracita	1
0320601	Kit ADVANCED H117 300	117	300	Blanco	1
0320701	Kit ADVANCED H117 350	117	350	Blanco	1
0320801	Kit ADVANCED H117 400	117	400	Blanco	1
0320901	Kit ADVANCED H117 450	117	450	Blanco	1
0321001	Kit ADVANCED H117 500	117	500	Blanco	1
0301168	Soporte frontal ADVANCED H117 tornillo premontado+taco 10 mm.	---	---	Galvanizado	200

ADVANCED H117

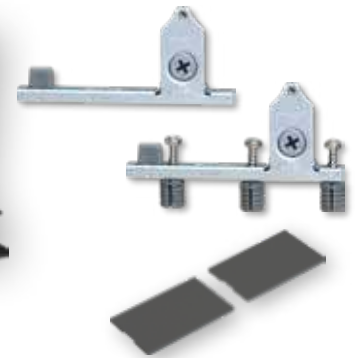

Embalaje - Kit ADVANCED H117



La H117, está especialmente indicada, para amueblamientos interiores de armarios. Sus 117 mm de altura son de gran ayuda para poder almacenar productos que requieren de mayor espacio por su volumen, pero que necesitan estar accesibles de forma sencilla.

Nuestro programa, ofrece también una atractiva posibilidad de combinar esta altura de cajón + barra para conseguir alturas de frente singulares.



ADVANCED H167 Antracita

Código	Descripción	Alto	Fondo	Acabado	Embalaje
0307007	Kit ADVANCED H167 300	167	300	Antracita	1
0307107	Kit ADVANCED H167 350	167	350	Antracita	1
0307207	Kit ADVANCED H167 400	167	400	Antracita	1
0307307	Kit ADVANCED H167 450	167	450	Antracita	1
0307407	Kit ADVANCED H167 500	167	500	Antracita	1
0321101	Kit ADVANCED H167 300	167	300	Blanco	1
0321201	Kit ADVANCED H167 350	167	350	Blanco	1
0321301	Kit ADVANCED H167 400	167	400	Blanco	1
0321401	Kit ADVANCED H167 450	167	450	Blanco	1
0321501	Kit ADVANCED H167 500	167	500	Blanco	1
0300968	Soporte frontal ADVANCED H167 tornillo premontado+taco 10 mm.	---	---	Galvanizado	200

ADVANCED H167

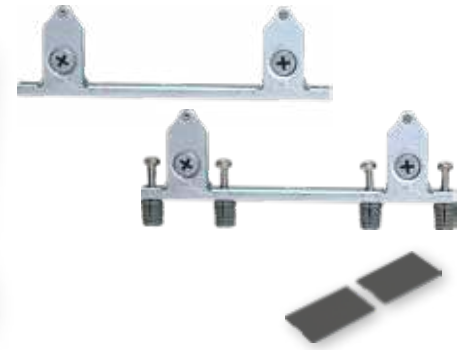

Embalaje - Kit ADVANCED H167



La altura 167 mm se ha convertido en la dimensión estrella dentro del amueblamiento de módulos de cajones. Gracias a la tendencia cada vez más creciente de fabricar los módulos bajos con altura superior, otorgando de esta manera una mayor capacidad, la versión 167 ha pasado a poseer un gran protagonismo dentro del mundo de la cocina. Su alta capacidad de almacenamiento, también la hacen indicada para albergar gran parte del día a día de la cocina como son los platos o botes de mayor altura.

Igualmente y en combinación con los cajones interiores, gozan de una excelente reputación entre los diseñadores que apuestan por esta altura más cajón interior para configurar sus diseños.



ADVANCEDH167 / Guía 50 Kg.



Los módulos cada vez mayores, de los diseños de cocina actuales, exigen guías de mayor capacidad de carga.

Especialmente en las gavetas de 167 de altura y fondo 500, se recomienda emplear nuestra guía *heavy*, preparada para albergar grandes capacidades con total fiabilidad y garantía.

Vajillas, alimentos, pequeños menajes, todo encuentra su sitio perfecto, funcionando con un óptimo deslizamiento y seguridad certificada.



Código	Descripción	Alto	Fondo	Acabado	Embalaje
0309807	Kit ADVANCED 50 Kg. H167	167	500	Antracita	1
0323401	Kit ADVANCED 50 Kg. H167	167	500	Blanco	1
0300968	Soporte frontal ADVANCED H167 tornillo premontado+taco 10 mm.	---	---	Galvanizado	200

La opción de Guía 50 Kg. está disponible opcionalmente en todos los cajones de fondo 500 ADVANCED. Consultar código con Departamento Comercial.

ADVANCED H87 / Guía Push

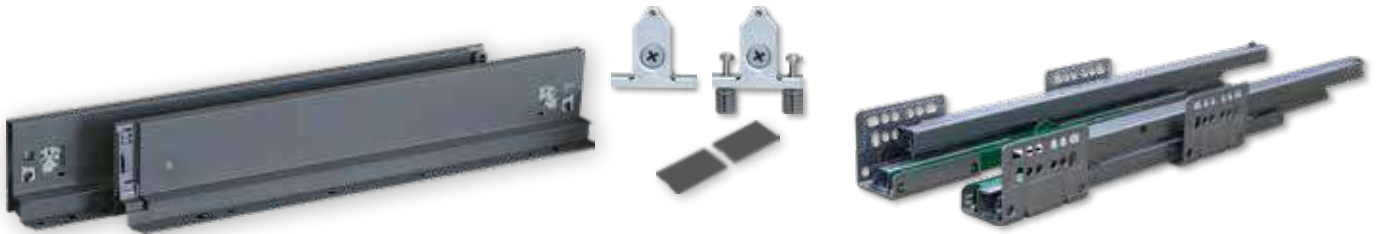

Nuestro cajón Advanced, equipa opcionalmente guía de Push, adaptándose así a la estética limpia del diseño actual.

Muy útil para combinar con cajones interiores, se convierte en el aliado perfecto para facilitar la extracción.



Código	Descripción	Alto	Fondo	Acabado	Embalaje
0309307	Kit ADVANCED Push H87	87	300	Antracita	1
0309407	Kit ADVANCED Push H87	87	350	Antracita	1
0309507	Kit ADVANCED Push H87	87	400	Antracita	1
0309607	Kit ADVANCED Push H87	87	450	Antracita	1
0309707	Kit ADVANCED Push H87	87	500	Antracita	1
0301068	Soporte frontal ADVANCED H87 tornillo premontado+taco 10 mm.	---	---	Galvanizado	400

























i La Guía Push está disponible en todas las opciones de fondos, acabados y alturas de nuestra gama ADVANCED. Consultar código con Departamento Comercial.



Calculador ADVANCED
(Corte frontales interiores)

Frontal Interior



Código	Descripción	Ancho Módulo	Alto	Longitud	Acabado	Embalaje
0307607	Frontal Interior H87 ADVANCED	600	104	---	Antracita	10 
0307707	Frontal Interior H87 ADVANCED	900	104	---	Antracita	10 
0307807	Frontal Interior H87 ADVANCED	1200	104	---	Antracita	10 
0307907	Frontal Interior H117 ADVANCED	600	142	---	Antracita	10 
0308007	Frontal Interior H117 ADVANCED	900	142	---	Antracita	10 
0308107	Frontal Interior H117 ADVANCED	1200	142	---	Antracita	10 
0308207	Frontal Interior H167 ADVANCED	600	190	---	Antracita	10 
0308307	Frontal Interior H167 ADVANCED	900	190	---	Antracita	10 
0308407	Frontal Interior H167 ADVANCED	1200	190	---	Antracita	10 
0321701	Frontal Interior H87 ADVANCED	600	104	---	Blanco	10 
0321801	Frontal Interior H87 ADVANCED	900	104	---	Blanco	10 
0321901	Frontal Interior H87 ADVANCED	1200	104	---	Blanco	10 
0322001	Frontal Interior H117 ADVANCED	600	142	---	Blanco	10 
0322101	Frontal Interior H117 ADVANCED	900	142	---	Blanco	10 
0322201	Frontal Interior H117 ADVANCED	1200	142	---	Blanco	10 
0322301	Frontal Interior H167 ADVANCED	600	190	---	Blanco	10 
0322401	Frontal Interior H167 ADVANCED	900	190	---	Blanco	10 
0322501	Frontal Interior H167 ADVANCED	1200	190	---	Blanco	10 
0311307	Perfil Frontal Interior ADVANCED	---	104	1200	Antracita	10
0305101	Perfil Frontal Interior ADVANCED	---	104	1200	Blanco	10
0311407	Barra Frontal Interior ADVANCED	---	16	1200	Antracita	50
0305201	Barra Frontal Interior ADVANCED	---	16	1200	Blanco	50
0310307	Set conectores frontal	---	104	---	Antracita	50 
0323901	Set conectores frontal	---	104	---	Blanco	50 
0310407	Set conectores frontal	---	142	---	Antracita	50 
0324001	Set conectores frontal	---	142	---	Blanco	50 
0310507	Set conectores frontal	---	190	---	Antracita	50 
0324101	Set conectores frontal	---	190	---	Blanco	50 



Perfil Frontal Interior 1200 Antracita

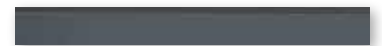

Barra Frontal Interior 1200 Antracita



H190 H142 H104
Set Conectores Frontal Antracita



Perfil Frontal Interior 1200 Blanco



Barra Frontal Interior 1200 Blanco



H190 H142 H104
Set Conectores Frontal Blanco

i El Perfil y Barra Frontal Interior ADVANCED se puede cortar y adaptar a medidas inferiores.



Perfil Frontal Interior + Barra Frontal Interior + Set Conectores frontal H142 Blanco



ADVANCED Lateral Cristal H167 Blanco + Frontal Interior Cristal Blanco



ADVANCED H167 + Frontal Interior Cristal Antracita

Frontal Interior personalizable



Calculador ADVANCED
(Corte frontales interiores)



Frontal Interior



Set conector frontal personalizable



Frontal Interior



Set conector frontal personalizable

Código	Descripción	Alto	Longitud	Acabado	Embalaje
0305101	Perfil Frontal Interior ADVANCED	104	1200	Blanco	10
0311307	Perfil Frontal Interior ADVANCED	104	1200	Antracita	10
0305801	Set Conector frontal personalizable	190	---	Blanco	50
0312007	Set Conector frontal personalizable	190	---	Antracita	50

i El Frontal Interior personalizable ADVANCED sólo podrá instalarse con Kit ADVANCEDH167. Los Set de conectores para personalizar, están pensados para que el cliente pueda insertar tanto acabados en madera, cristal, ceramicos, etc. con un espesor de 10 mm. y adaptables a cualquier fondo de cajón.



ADVANCED H87 Antracita + Alzada Cristal



Kit ADVANCED Cristal Blanco 500 H167 + Frontal Interior Cristal Blanco

Laterales de Cristal o personalizables

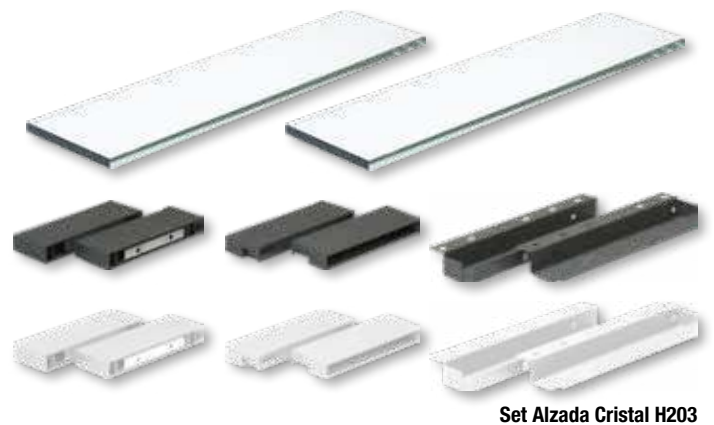
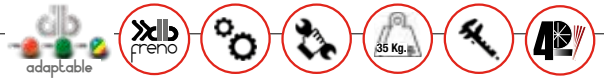

Código	Descripción	Alto	Fondo	Acabado	Embalaje
0311507	Kit ADVANCED Cristal 500	180	500	Antracita / Transparente	1
0305301	Kit ADVANCED Cristal 500	180	500	Blanco / Transparente	1
0300968	Soporte frontal ADVANCED H167 tornillo premontado+taco 10 mm.	---	---	Galvanizado	200
0309907	Set Alzada Cristal H203	203	500	Antracita	5
0323501	Set Alzada Cristal H203	203	500	Blanco	5
0311607	Set Conectores para personalizar alzada H203	203	---	Antracita	50 
0305401	Set Conectores para personalizar alzada H203	203	---	Blanco	50 

i La altura reflejada en la tabla corresponde a la suma del lateral del cajón más el set correspondiente.
Los Set de conectores para personalizar, están pensados para que el cliente pueda insertar tanto acabados en madera, cristal, ceramicos, etc. con un espesor de 10 mm. y adaptables a cualquier fondo de cajón.



Set Barra Gaveta H210 mm.





Aplicación Set Barra Gaveta H210 en
cajón de altura 87 mm. y 117 mm.



Detalle fijación Set Barra Gaveta H210 mm.

Set barras gaveta ADVANCED

Código	Descripción	Alto	Fondo	Acabado	Embalaje
0311007	Set Barra Gaveta Altura Libre	---	500	Antracita	50 
0324401	Set Barra Gaveta Altura Libre	---	500	Blanco	50 
0307507	Set Barra Gaveta H210	210	500	Antracita	20
0321601	Set Barra Gaveta H210	210	500	Blanco	20

i El set barra gaveta altura libre, nos permite como su nombre indica, instalar el juego de barras a una altura a determinar por el cliente en la trasera. Igualmente, nos permite la opción de instalar tantos juegos de barras como se precisen.



Set Barra Gaveta Alt. Libre Antracita



Set Barra Gaveta Alt. Libre Blanco



Set Barra Gaveta H210 Antracita



Set Barra Gaveta H210 Blanco



Set Barra Gaveta altura Libre



CARONTE



POR QUÉ ELEGIR CARONTE



Dossier técnico
CARONTE



SGS

100.000
ciclos de apertura

**Montaje /
Desmontaje
rápido**



**Fijaciones y
regulaciones
100%
metálicas**



**Óptimo
nivel de
regulaciones**



**Freno
encapsulado**



**Calidad de
acabados**



**Sistemas de
Reciclaje**



**5 Fondos
300 mm.
350 mm.
400 mm.
450 mm.
500 mm.**



**Protector
fondo cajón
en diferentes
acabados**

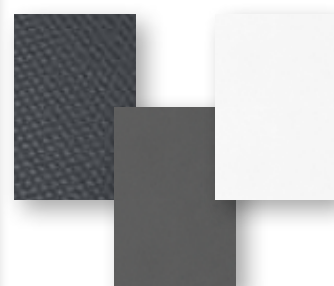

**Set barra
gaveta 150 /
180 y Set de
barra doble 180**



**Organizador
de cajones en
ABS/Madera/
Metálicos**





Kit cajón Caronte 500 mm. + Set barra cuadrada gaveta H150 mm.



Kit cajón Caronte 500 mm. + Set doble barra cuadrada gaveta H180 mm.

Caronte

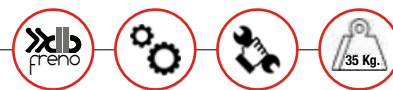

Código	Descripción	Alto	Fondo	Acabado	Embalaje
0307620	Kit cajón Caronte	90	300	Gris	1
0307720	Kit cajón Caronte	90	350	Gris	1
0307820	Kit cajón Caronte	90	400	Gris	1
0307920	Kit cajón Caronte	90	450	Gris	1
0113920	Kit cajón Caronte	90	500	Gris	1



Set barra gaveta cuadrada

Código	Descripción	Alto	Fondo	Acabado	Embalaje
0309820	Set barra cuadrada gaveta	150	500	Gris	20 
0114020	Set barra cuadrada gaveta	180	500	Gris	20 
0309020	Set doble barra cuadrada gaveta	180	500	Gris	20 



Kit cajón Caronte 500 mm.



Set frontal cajón/gaveta interior



Código	Descripción	Alto	Ancho	Acabado	Embalaje
0317120	Perfil frontal cajón interior	98	1200	Gris	10
0317220	Barra frontal cajón interior	23	1200	Gris	50
0315420	Set conectores cajón interior	98	---	Antracita	50
0315320	Set conectores gaveta interior	222	---	Antracita	50



Perfil frontal cajón interior
+ Set conectores H90



Perfil frontal cajón interior
+ Barra frontal+ Set conectores H180

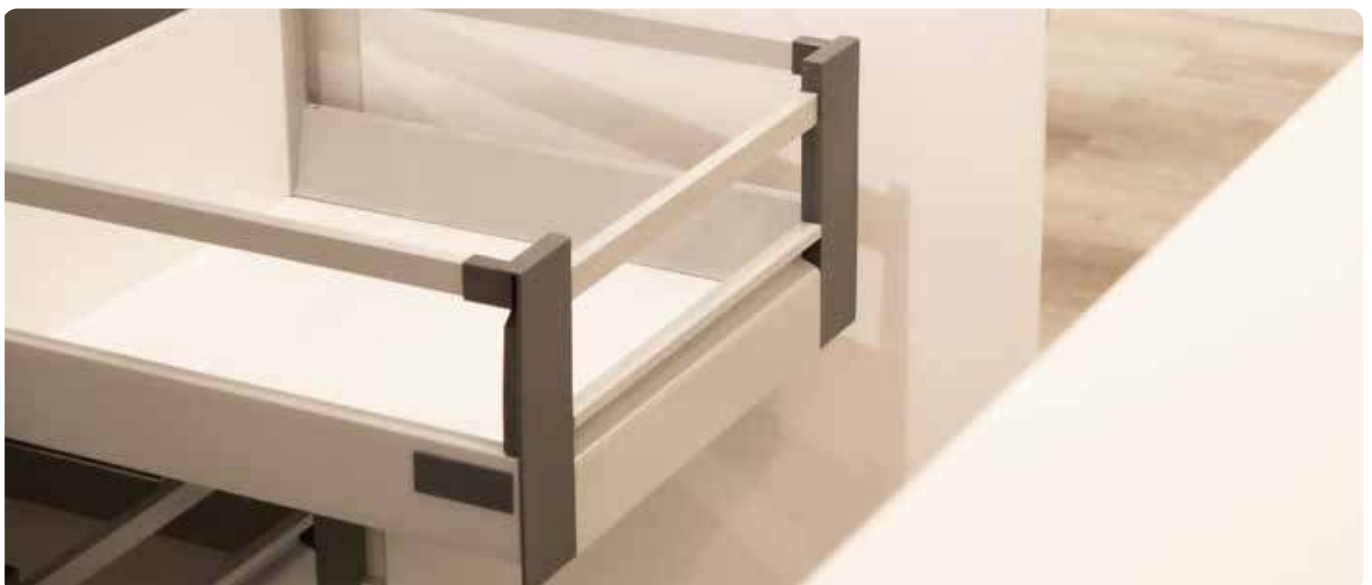

Distanciadores

Código	Descripción	Espesor	Alto	Ancho	Acabado	Embalaje
0318620	Distanciador	25	75	67	Gris	100
0300102	Distanciador	25	75	67	Antracita	100

i Indicado para librar las bisagras en la extracción de cajones interiores y válidos para cajones Advanced, Caronte y guías Synkron. Para otros cajones o guías consultar con Dpto.Comercial.



Vista frontal

Lateral

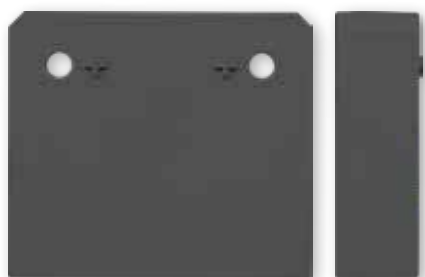

Vista frontal

Lateral

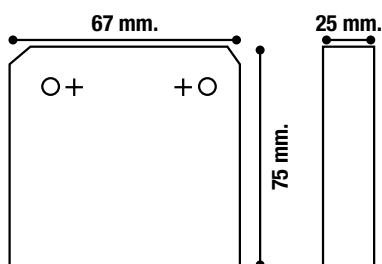

Conector fondo /frente cajón

Código	Descripción	Acabado	Embalaje
0314920	Conector fondo/frente cajón	Gris	500

i El **Conector fondo / frente cajón** se emplea para eliminar la luz entre el frente y el cajón, así como para evitar el pandeo de la base del cajón.

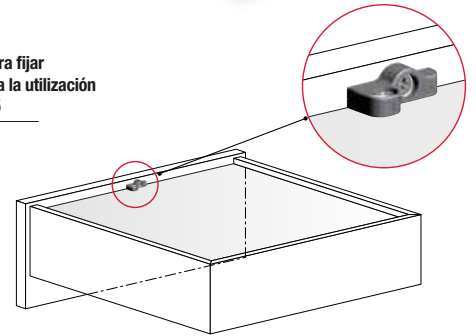
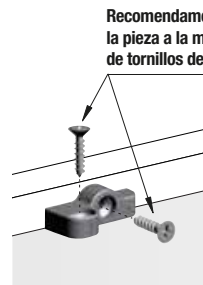
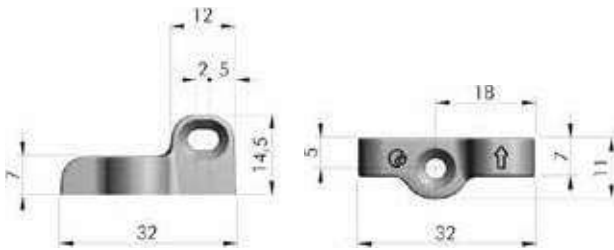



ORGANIZACIÓN



Sistema de Organización LiniQ

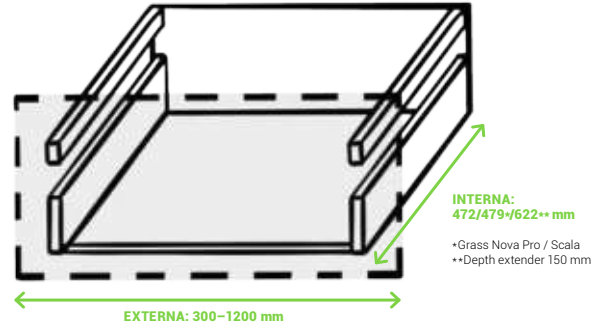

Las bases del programa LiniQ, está fabricadas para que su aplicación sea válida tanto en cajones de perfil recto, como en cajones de perfil curvado.

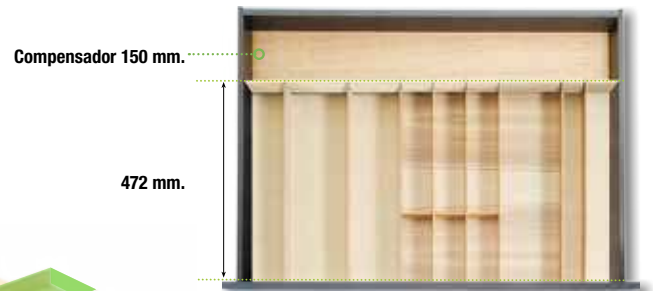
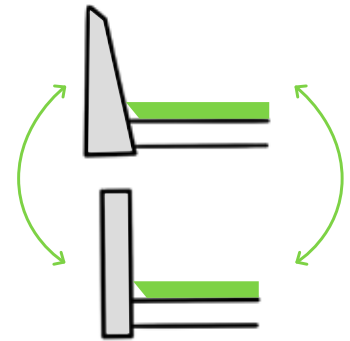

Todos los elementos para insertar en cajón del programa LiniQ, tienen un fondo de 472 mm que lo hacen apto para la mayoría de los cajones del mercado a excepción del modelo Nova Pro / Scala de Grass. Para este modelo, es necesario instalar el suplemento de 600 o 1200 mm con el que suplementar el espacio.



Estos accesorios deben insertarse, dentro del diagrama verde.

Accesorios **LiniQ** para cajón



Accesorios **LiniQ** para gaveta

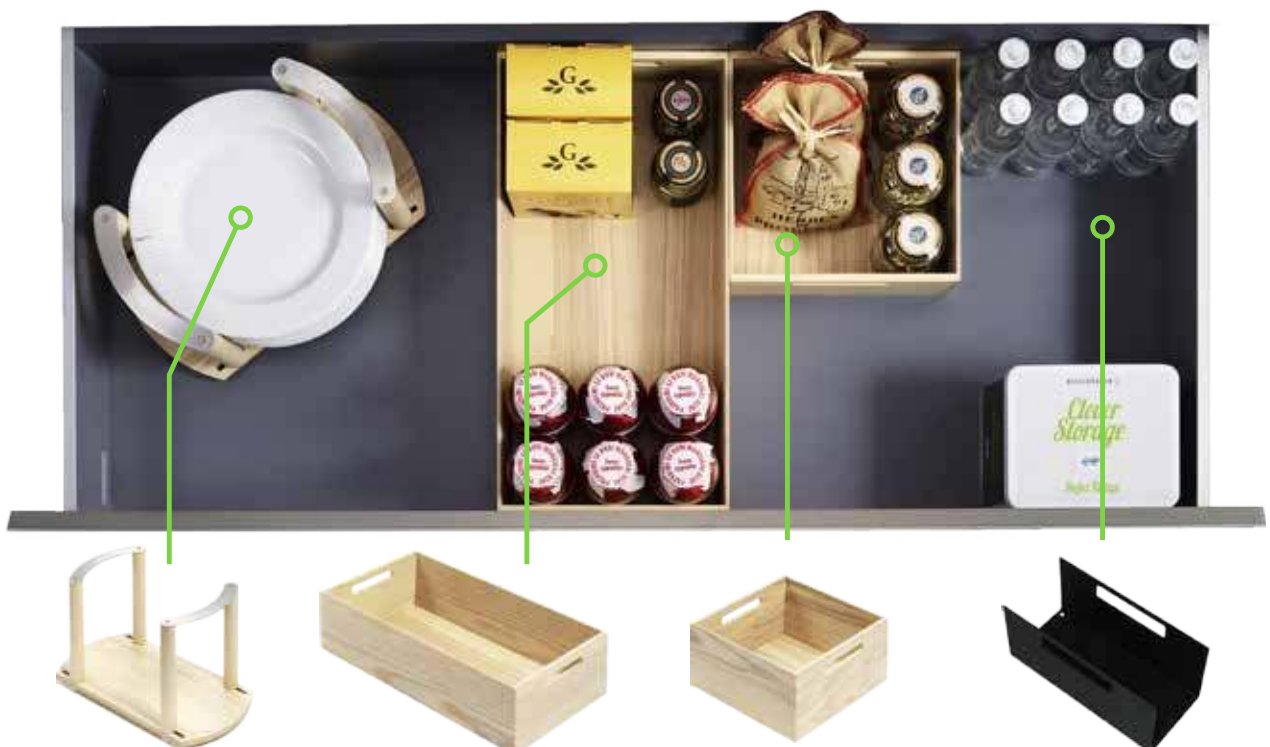

LiniQ 300 mm.



LiniQ 400 - 450 mm.



LiniQ 500 - 600 mm.



LiniQ 800 - 900 mm.



LiniQ 1000 - 1200 mm.

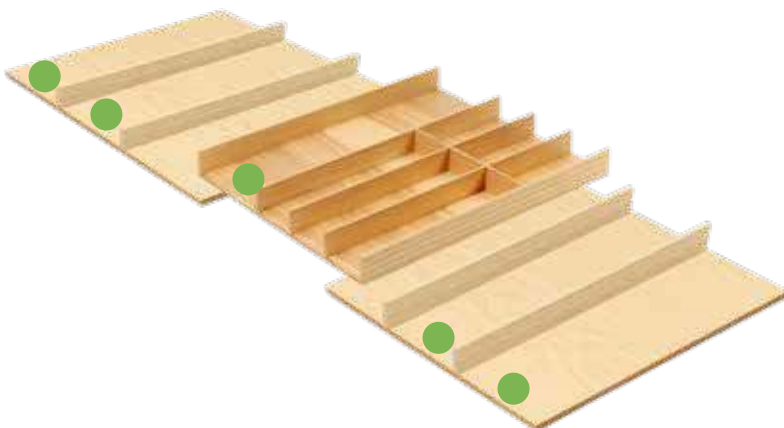

ROBLE NATURAL

Organizador de cajón LiniQ



Código	Descripción	Ancho	Alto	Fondo	Acabado	Embalaje													
0304578	Cubertero	400-450	49	472	Roble Natural	1													
0304678	Cubertero	500-600	49	472	Roble Natural	1													
0304778	Cubertero	800-900	49	472	Roble Natural	1													
0304878	Cubertero	1000-1200	49	472	Roble Natural	1													
0303378	Caja Multifunción	152	49	472	Roble Natural	1													
0303478	Divisor	137	37,5	472	Roble Natural	1													
0303578	Especiero (3)	137	26	472	Roble Natural	1													
0303678	Porta Cuchillos	137	26	472	Roble Natural	1													
0303778	Porta Rollos	137	45	472	Roble Natural	1													
0303878	Compensador	600	49	7	Roble Natural	1													
0303978	Compensador	1200	7	Roble Natural	1	0304078	Suplemento	600	49	150	Roble Natural	1	0304178	Suplemento	1200	49	150	Roble Natural	1
0304078	Suplemento	600	49	150	Roble Natural	1													
0304178	Suplemento	1200	49	150	Roble Natural	1													

i Combinar Divisor, Especiero o Porta Cuchillos con Caja Multifunción para una correcta utilización.
 El **Compensador**, está indicado para completar la medida de fondo de las versiones Nova Pro y Scala de Grass.
 El **Suplemento**, está indicado para suplementar la serie LiniQ en cajones de fondo superior a 500 mm.



Cubertero



Caja Multifunción

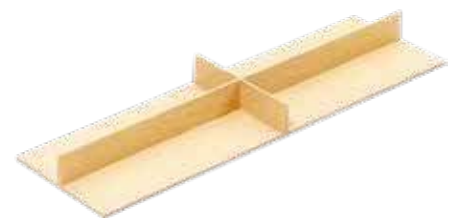

● Divisor



● Especiero (3)



● Porta Cuchillos



● Porta Rollos



Compensador



Suplemento

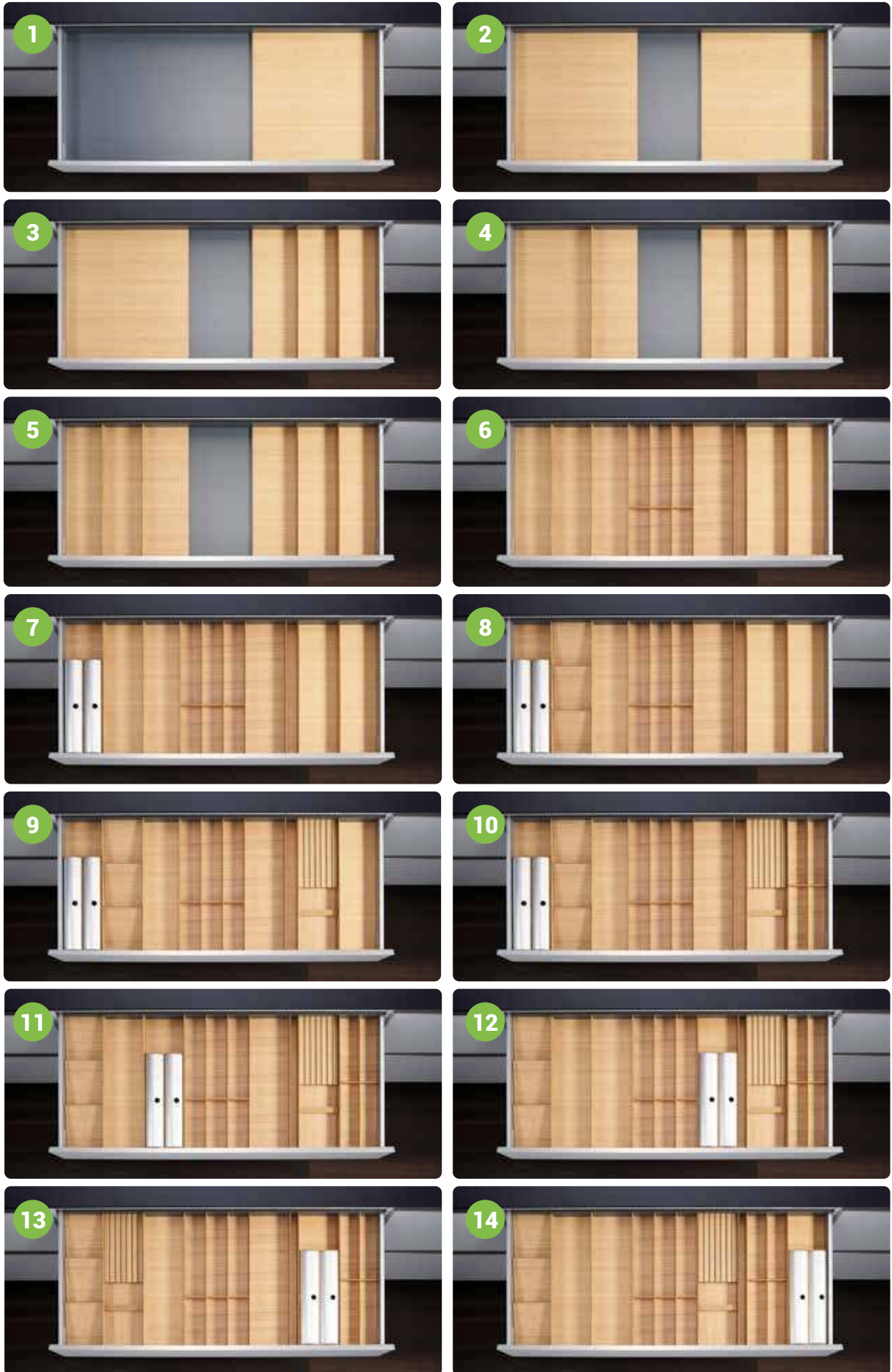







LiniQ 300 mm.

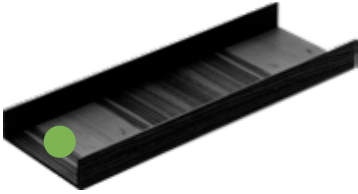

LiniQ 400 - 450 mm.

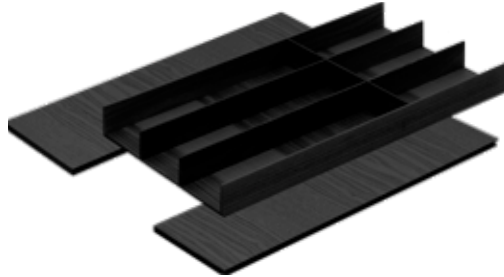

LiniQ 500 - 600 mm.

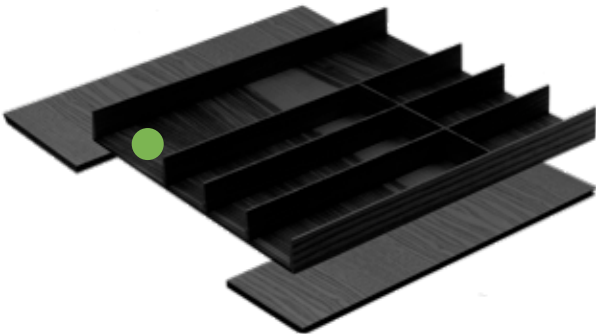

LiniQ 800 - 900 mm.

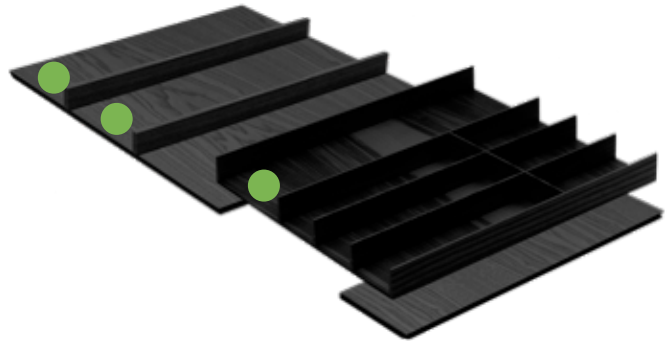

LiniQ 1000 - 1200 mm.

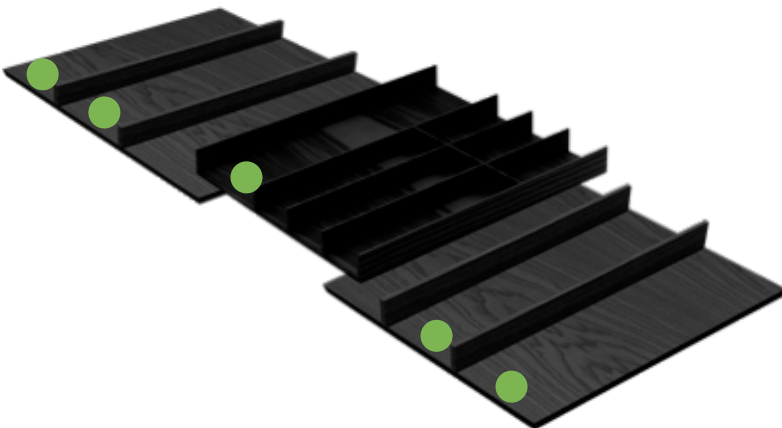

NEGRO CENIZA

Organizador de cajón LiniQ



Código	Descripción	Ancho	Alto	Fondo	Acabado	Embalaje
0313607	Cubertero	400-450	49	472	Negro Ceniza	1
0313707	Cubertero	500-600	49	472	Negro Ceniza	1
0313807	Cubertero	800-900	49	472	Negro Ceniza	1
0313907	Cubertero	1000-1200	49	472	Negro Ceniza	1
0312307	Caja Multifunción	152	49	472	Negro Ceniza	1
0312407	Divisor	137	37,5	472	Negro Ceniza	1
0312507	Especiero (3)	137	26	472	Negro Ceniza	1
0312607	Porta Cuchillos	137	26	472	Negro Ceniza	1
0312707	Porta Rollos	137	45	472	Negro Ceniza	1
0312807	Compensador	600	49	7	Negro Ceniza	1
0312907	Compensador	1200	49	7	Negro Ceniza	1
0313007	Suplemento	600	49	150	Negro Ceniza	1
0313107	Suplemento	1200	49	150	Negro Ceniza	1

i Combinar Divisor, Especiero o Porta Cuchillos con Caja Multifunción para una correcta utilización.
 El **Compensador**, está indicado para completar la medida de fondo de las versiones Nova Pro y Scala de Grass.
 El **Suplemento**, está indicado para suplementar la serie LiniQ en cajones de fondo superior a 500 mm.

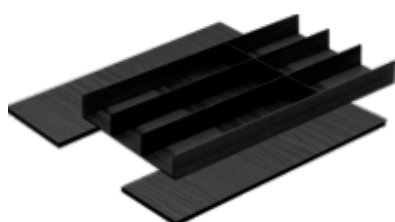

Cubertero

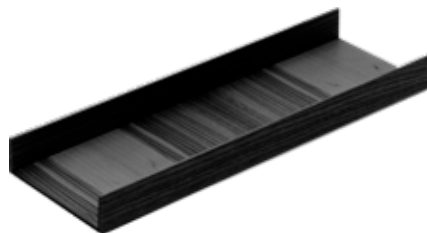

Caja Multifunción

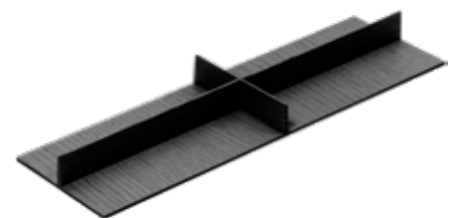

● Divisor

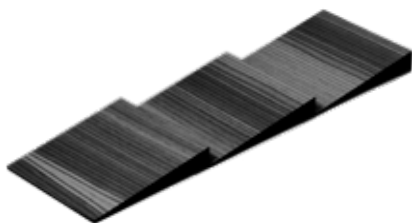

● Especiero (3)

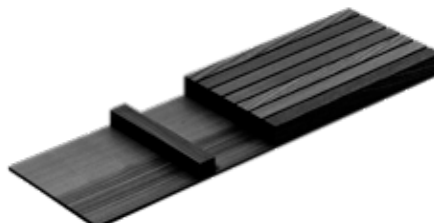

● Porta Cuchillos



● Porta Rollos



Compensador

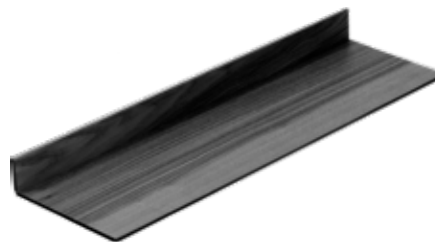

Suplemento



Organizador de gaveta LiniQ



Código	Descripción	Ancho	Alto	Fondo	Acabado	Embalaje
0304278	Cesta Cuadrada	236	120	236	Roble Natural	1
0304378	Cesta Rectangular	236	120	472	Roble Natural	1
0304478	Porta Platos	340	191	180	Roble Natural	1
0313207	Cesta Cuadrada	236	120	236	Negro Ceniza	1
0313307	Cesta Rectangular	236	120	472	Negro Ceniza	1
0313407	Porta Platos	340	191	180	Negro Ceniza	1
0305407	"U" Gaveta metálica	225	102	99	Antracita	1



Cesta cuadrada



Cesta rectangular



Porta Platos



Cesta cuadrada



Cesta rectangular



Porta Platos



"U" Gaveta metálica
(común para ambos acabados)

Organizador de cajón SpaceLine

Código	Descripción	Ancho Módulo	Fondo	Acabado	Embalaje
0315020	Kit SpaceLine	600	473	Aluminio / Antracita / Roble	1
0315120	Kit SpaceLine	900	473	Aluminio / Antracita / Roble	1

i Kit SpaceLine incorpora la alfombra antideslizante **Tessuto** en ambas medidas.



Protector de cajón antideslizante Tessuto



Código	Descripción	Ancho	Fondo	Acabado	Embalaje
0315220	Antideslizante Tessuto	1124	473	Antracita	10

i Producto a juego con **SpaceLine**. Este protector se puede usar para completar espacios libres, cuando empleen cajones de medidas superiores con **Kits SpaceLine** en la medida de 600 y 900. Se suministra en planchas.





Cubertero ADVANCED / Complementos



Cubertero ADVANCED Antracita



Cubertero ADVANCED Blanco



Separador



Portacuchillos



Portaespecies

GRAN CAPACIDAD



57,5 MM

Código	Descripción	Ancho Módulo	Ancho	Fondo	Acabado	Embalaje
0308507	Cubertero ADVANCED	400	325	473	Antracita	20
0308607	Cubertero ADVANCED	450	375	473	Antracita	20
0308707	Cubertero ADVANCED	500	425	473	Antracita	20
0308807	Cubertero ADVANCED	600	525	473	Antracita	20
0309207	Cubertero ADVANCED	700	625	473	Antracita	10
0308907	Cubertero ADVANCED	800	725	473	Antracita	10
0309007	Cubertero ADVANCED	900	825	473	Antracita	10
0311107	Cubertero ADVANCED	1000	925	473	Antracita	10
0311207	Cubertero ADVANCED	1200	1125	473	Antracita	10
0322601	Cubertero ADVANCED	400	325	473	Blanco	20
0322701	Cubertero ADVANCED	450	375	473	Blanco	20
0322801	Cubertero ADVANCED	500	425	473	Blanco	20
0322901	Cubertero ADVANCED	600	525	473	Blanco	20
0323301	Cubertero ADVANCED	700	625	473	Blanco	10
0323001	Cubertero ADVANCED	800	725	473	Blanco	10
0323101	Cubertero ADVANCED	900	825	473	Blanco	10
0324501	Cubertero ADVANCED	1000	925	473	Blanco	10
0324601	Cubertero ADVANCED	1200	1125	473	Blanco	10
0309107	Separador	---	---	---	Antracita	100
0323201	Separador	---	---	---	Blanco	100
0102177	Portacuchillos	---	---	---	Haya	1
0112720	Portaespecies	---	---	---	Haya	1

i Consultar con el Dpto. Comercial la compatibilidad de medidas con otras marcas.





Cubertero Caronte / Complementos

Código	Descripción	Ancho Módulo	Ancho	Fondo	Acabado	Embalaje
0305220	Cubertero Caronte	300	220	473	Gris	20
0305320	Cubertero Caronte	350	270	473	Gris	20
0305420	Cubertero Caronte	400	320	473	Gris	20
0305520	Cubertero Caronte	450	370	473	Gris	20
0305820	Cubertero Caronte	500	420	473	Gris	20
0305920	Cubertero Caronte	600	520	473	Gris	20
0306020	Cubertero Caronte	700	620	473	Gris	10
0306120	Cubertero Caronte	800	720	473	Gris	10
0306220	Cubertero Caronte	900	820	473	Gris	10
0306320	Cubertero Caronte	1000	920	473	Gris	10
0306420	Cubertero Caronte	1200	1120	473	Gris	10
0112620	Separador	---	---	----	Gris	100 
0102177	Portacuchillos	----	---	----	Haya	1
0112720	Portaespecies	----	---	----	Haya	1



Cubertero Caronte



Separador



Portacuchillos



Portaespecies

GRAN CAPACIDAD

57,5 MM

i Consultar con el Dpto. Comercial la compatibilidad de medidas con otras marcas.





Cubertero Linea 462 / Complementos



Cubertero Linea 462



Separador



Portacuchillos



Portaespecies

Código	Descripción	Ancho Módulo	Ancho Fondo	Acabado	Embalaje
0315920	Cubertero Linea 462	400	306	462	Gris 20
0316020	Cubertero Linea 462	450	355	462	Gris 20
0316320	Cubertero Linea 462	500	406	462	Gris 20
0316420	Cubertero Linea 462	600	506	462	Gris 20
0316520	Cubertero Linea 462	700	606	462	Gris 10
0316620	Cubertero Linea 462	800	706	462	Gris 10
0316720	Cubertero Linea 462	900	806	462	Gris 10
0316820	Cubertero Linea 462	1000	906	462	Gris 10
0316920	Cubertero Linea 462	1200	1106	462	Gris 10
0112620	Separador	---	---	----	Gris 100 
0102177	Portacuchillos	----	---	----	Haya 1
0112720	Portaespecies	----	---	----	Haya 1

i La medida del Cubertero Linea 462, está pensado para insertar en el cajón Atira de Hettich.

GRAN CAPACIDAD



57,5 MM



Cubertero Universal / Complementos



Código	Descripción	Ancho Módulo	Ancho	Fondo	Acabado	Embalaje
0111520	Cubertero Universal	300	236	480	Gris	20
0111620	Cubertero Universal	350	286	480	Gris	20
0111720	Cubertero Universal	400	336	480	Gris	20
0111820	Cubertero Universal	450	386	480	Gris	20
0111920	Cubertero Universal	500	436	480	Gris	20
0112020	Cubertero Universal	600	536	480	Gris	20
0112120	Cubertero Universal	700	636	480	Gris	10
0112220	Cubertero Universal	800	736	480	Gris	10
0112320	Cubertero Universal	900	836	480	Gris	10
0112420	Cubertero Universal	1000	936	480	Gris	10
0112520	Cubertero Universal	1200	1136	480	Gris	10
0112620	Separador	---	---	----	Gris	100 
0102177	Portacuchillos	----	---	----	Haya	1
0112720	Portaespecies	----	---	----	Haya	1



Cubertero Linea Universal



Separador



Portacuchillos



Portaespecies

i Este cubertero se podrá cortar y adaptar a prácticamente cualquier cajón del mercado. Consultar con el Dpto. Comercial la compatibilidad de medidas con otras marcas.



GRAN CAPACIDAD

57,5 MM



Divisor interior de cajón universal

Código	Descripción	Grosor	Alto	Fondo	Acabado	Embalaje
0305901	Divisor interior cajón universal	10	60	473	Blanco	50
0318520	Divisor interior cajón universal	10	60	473	Gris	50
0312107	Divisor interior cajón universal	10	60	473	Antracita	50

i El **Divisor interior de cajón universal** viene dotado con un sistema expansor en ambos extremos para una perfecta fijación en el cajón.



Cover cajón ADVANCED



Código	Descripción	Alto	Fondo	Longitud	Acabado	Embalaje
0300185	Perfil Cover cajón ADVANCED	12	---	3000	Cobre	60
0310190	Perfil Cover cajón ADVANCED	12	---	3000	Ínox U6	60
0300285	Perfil Cover cajón ADVANCED	12	---	3000	Oro	60
0300385	Set Cover cajón ADVANCED	87	500	---	Negro Mate	24
0300485	Set Cover cajón ADVANCED	117	---	Negro Mate	19	
0310290	Set Cover cajón ADVANCED	167	500	---	Negro Mate	19

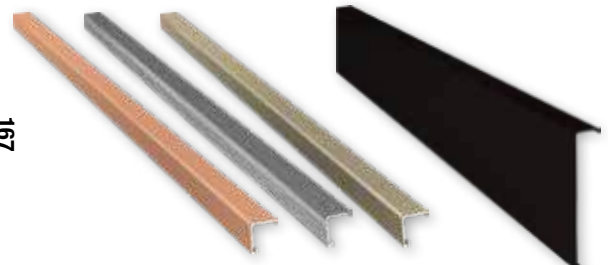
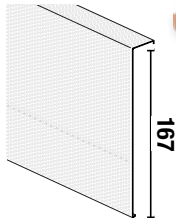
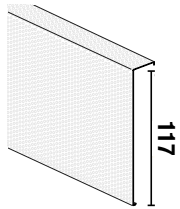
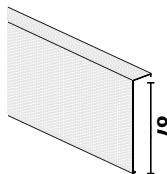
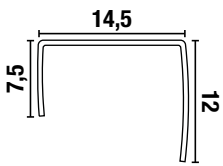

Perfil Cover

Cover



Perfil Cover Cobre



Set Cover Negro Mate



Montaje Cover H87 Negro Mate



Protector de cajón antideslizante Ago Tex

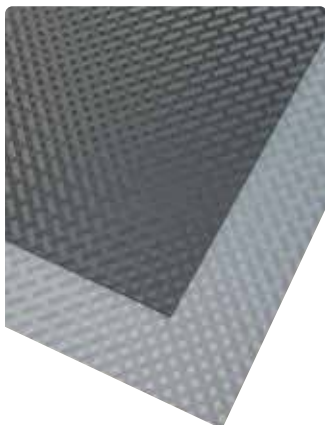

Código	Descripción	Ancho	Fondo	Acabado	Embalaje
0304820	Antideslizante Ago Tex	525	473	Gris	10
0304920	Antideslizante Ago Tex	825	473	Gris	10
0305120	Antideslizante Ago Tex	1125	473	Gris	10
0300207	Antideslizante Ago Tex	525	473	Antracita	10
0300307	Antideslizante Ago Tex	825	473	Antracita	10
0300407	Antideslizante Ago Tex	1125	473	Antracita	10

i Se suministra en planchas.

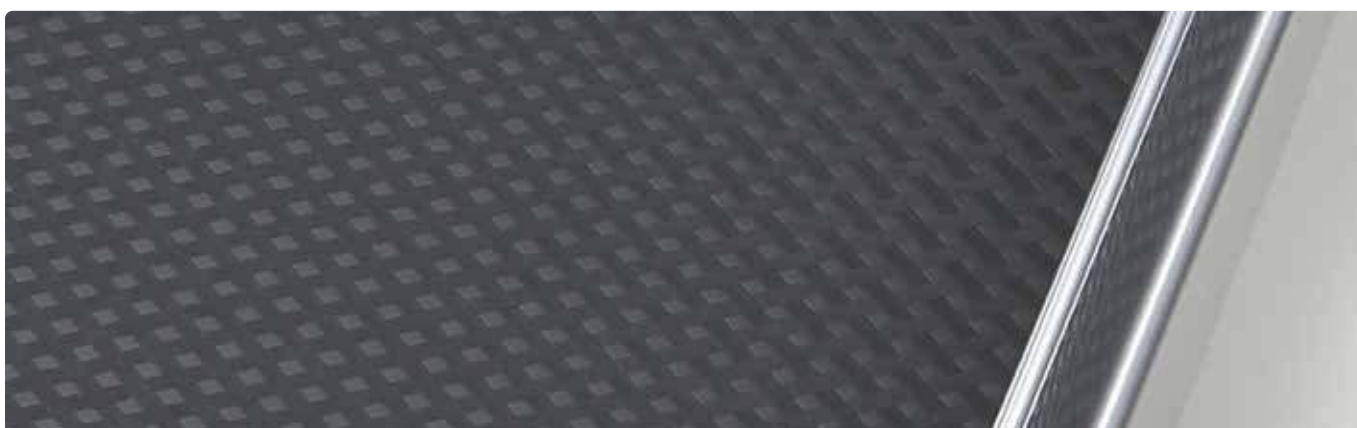

Protector de cajón antideslizante Line

Código	Descripción	Fondo	Acabado	Embalaje
0313507	Antideslizante Line	473	Negro	20 Metros





Protector de cajón Textil

Código	Descripción	Fondo	Acabado	Embalaje
0317020	Protector Textil	462	Gris	20 Metros
0309420	Protector Textil	480	Gris	20 Metros
0109920	Protector Textil	473	Gris	20 Metros
0300507	Protector Textil	473	Antracita	20 Metros
0102601	Protector Textil	473	Blanco	20 Metros

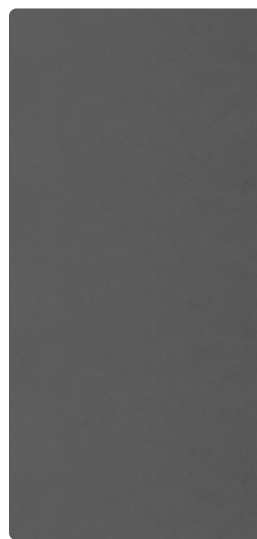
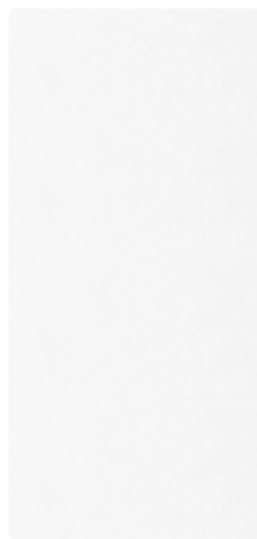

Protector de cajón Point



Código	Descripción	Fondo	Acabado	Embalaje
0310520	Protector Point	480	Gris	20 Metros

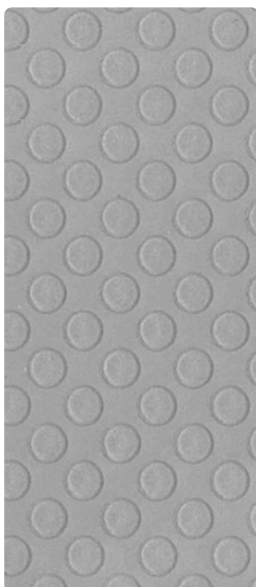



SpaceFlexx



Código	Descripción	Ancho	Alto	Fondo	Acabado	Embalaje
0317320	SpaceFlexx	520	130	472	Cromo/Gris	1



Base perforada/Pivote



Base Perforada



Pivote Universal

Código	Descripción	Ancho Módulo	Ancho	Fondo	Grosor	Acabado	Embalaje
0100477	Base Perforada Universal	600	530	500	16	Haya	1
0100577	Base Perforada Universal	900	830	500	16	Haya	1
0100677	Base Perforada Universal	1200	1130	500	16	Haya	1
0101977	Pivote Universal H20	---	---	---	---	Haya	6

i La **Base perforada** puede sustituir el fondo del cajón, al tener un espesor de 16 mm. o ponerlo sobre el mismo.



Portaplatos Adaptable

Código	Descripción	Alto	Diámetro	Fondo	Acabado	Embalaje
0100107	Portaplatos	175	265/410	160	Gris	1



i Portaplatos regulable en diámetro.





Guía Shelf (Extracción total)



Código	Descripción	Fondo	Acabado	Embalaje
0302768	Jgo. Guía Shelf con freno	400	Cincado	20
0302868	Jgo. Guía Shelf con freno	450	Cincado	20
0302968	Jgo. Guía Shelf con freno	500	Cincado	20
0303068	Jgo. Guía Shelf Push	400	Cincado	20
0303168	Jgo. Guía Shelf Push	450	Cincado	20
0303268	Jgo. Guía Shelf Push	500	Cincado	20
0320020	Set maneta de fijación 3D	---	Gris	20
0303368	Retenedor guía Shelf	---	Cincado	20

i La **Guía Shelf**, está certificada por LGA para 50.000 ciclos de apertura con una capacidad de carga de 30 Kg. Posibilidad de instalar 2 juegos de guías para aumentar capacidad de carga y ancho de la bandeja extraíble.

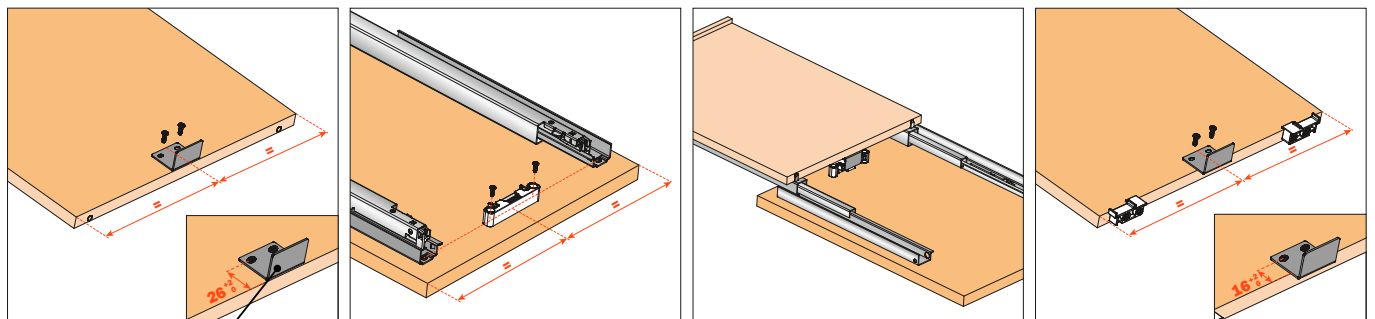
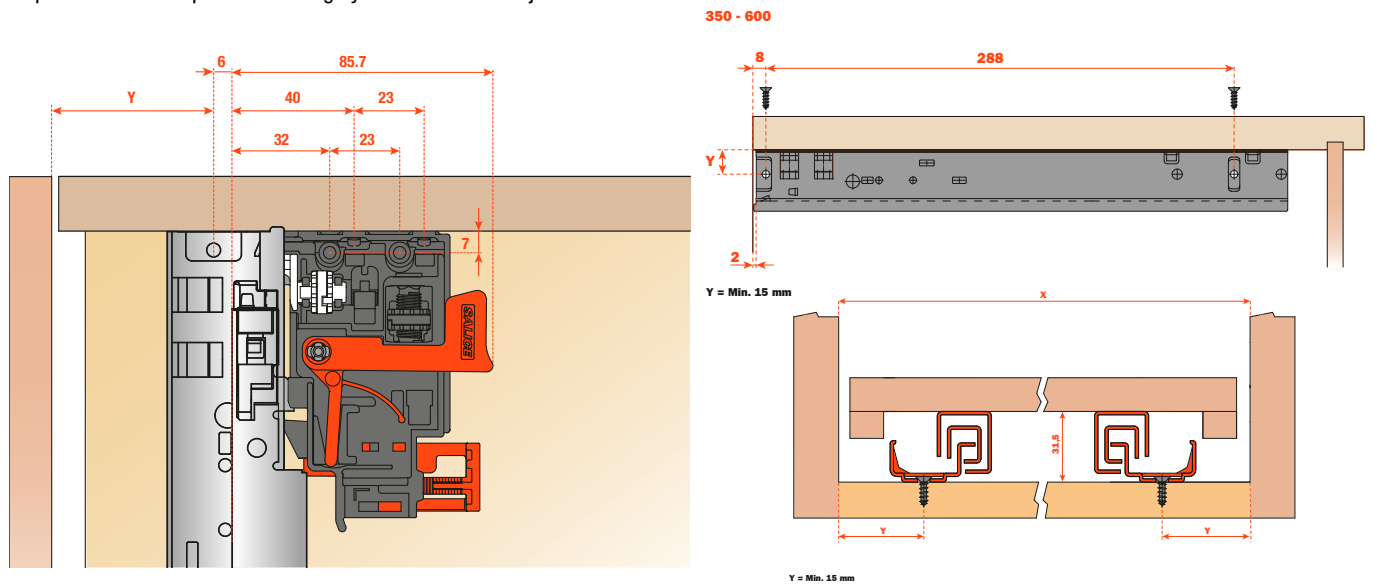

Retenedor guía Shelf

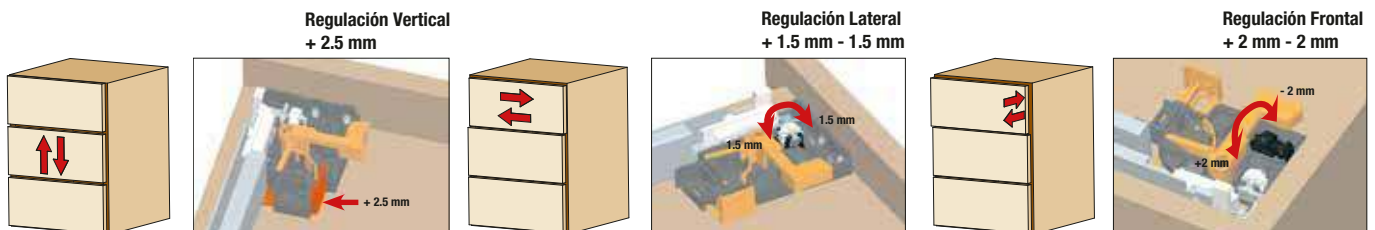



Guía Synkron (Extracción total)



EVOLUTION

Código	Descripción	Fondo	Acabado	Embalaje
0301268	Jgo. Guía Synkron	300	Cincado	10
0301368	Jgo. Guía Synkron	350	Cincado	10
0301468	Jgo. Guía Synkron	400	Cincado	10
0301568	Jgo. Guía Synkron	450	Cincado	10
0301668	Jgo. Guía Synkron	500	Cincado	10

i La **Guía Synkron** está certificada por SGS para 100.000 ciclos de apertura con una capacidad de carga de 35 Kg.
El Set maneta regulación 3D se suministra incluido con el Juego de guías Synkron.

SGS
100.000
ciclos de apertura



Maneta regulación 3D



Instrucciones de montaje

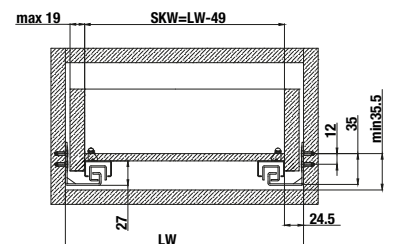
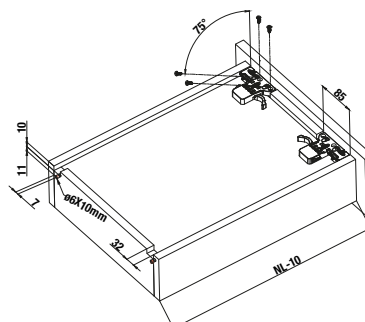
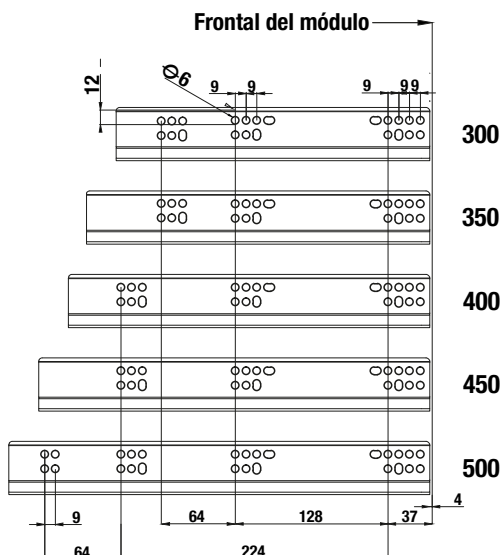

LT min = NL + 3

Cajón estandar
Standar drawer

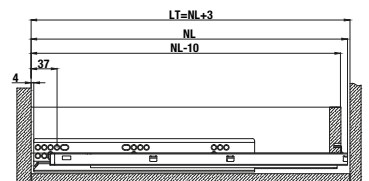

Cajón Interior
Internal drawer

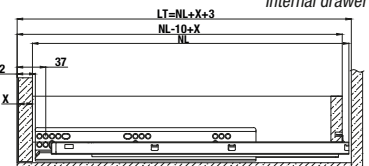

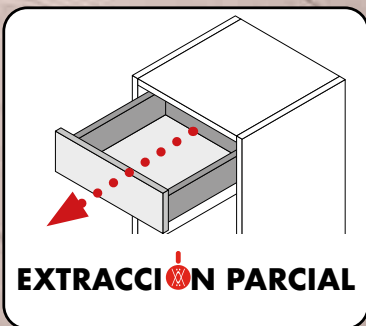

Guía Sigma (Extracción parcial)



Código	Descripción	Fondo	Acabado	Embalaje
0302268	Jgo. Guía Sigma	300	Cincado	20
0302368	Jgo. Guía Sigma	350	Cincado	20
0302468	Jgo. Guía Sigma	400	Cincado	20
0302568	Jgo. Guía Sigma	450	Cincado	20
0302668	Jgo. Guía Sigma	500	Cincado	20

i La Guía Sigma está certificada por SGS para 50.000 Ciclos de apertura con una capacidad de carga de 25 Kg.

SGS
50.000
ciclos de apertura



Instrucciones de montaje

